



Maswell 5G 4X4 MIMO Antenna Screw Mount IP67 L Plate Mount Street Lamp

AN_Master_Cubic-4C-LP



Schematic Picture

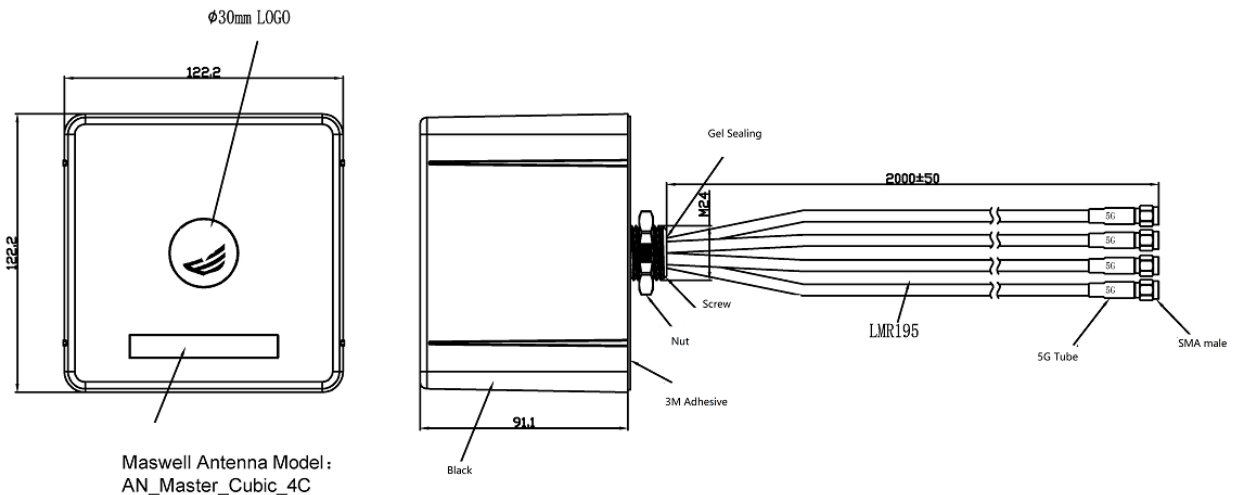

Suzhou Maswell Communication Technology Co., Ltd

Add: Floor 3, Building 6, No. 88 Zhenbei Road, High-tech District, Suzhou 215153, Jiangsu, China

[Http://www.maswelltech.com](http://www.maswelltech.com)

E-mail: Sales@maswelltech.com

Maswell 5G 4X4 MIMO Antenna Screw Mount IP67

L Plate Mount Street Lamp

AN_Master_Cubic-4C-LP

Specifications

Item	Specifications	
Antenna 1: 5G/4G LTE/WiFi6E/UWB	Frequency Range	600MHz~8.0GHz
	Polarization	Linear
	Gain	Up to 6.0dBi (20cm Length)
	V.S.W.R	average 3.0
	Efficiency	>50%
Antenna 2: 5G/4G LTE/WiFi6E/UWB	Frequency Range	600MHz~8.0GHz
	Polarization	Linear
	Gain	Up to 6.0dBi (20cm Length)
	V.S.W.R	average 3.0
	Efficiency	>50%
Antenna 3: 5G/4G LTE/WiFi6E/UWB	Frequency Range	600MHz~8.0GHz
	Polarization	Linear
	Gain	Up to 6.0dBi (20cm Length)
	V.S.W.R	average 3.0
	Efficiency	>50%
Antenna 4: 5G/4G LTE/WiFi6E/UWB	Frequency Range	600MHz~8.0GHz
	Polarization	Linear
	Gain	Up to 6.0dBi (20cm Length)
	V.S.W.R	average 3.0
	Efficiency	>50%
Mechanical	Dimension	121mm *121mm*91mm
	Cable	LMR195 1m or Customised
	Mounting Method	L plate (Supplied) U bolt and Screw
	Connector	SMA male
Environmental	Operating Temperature	-40°C~+85°C
	Waterproof Grade	IP67
	Relative Humidity	Up to 95%
	Vibration	10 to 55Hz with 1.5mm amplitude 2hours
	Environmentally Friendly	ROHS Compliant

Maswell 5G 4X4 MIMO Antenna Screw Mount IP67 L Plate Mount Street Lamp

AN_Master_Cubic-4C-LP

S11 Reflection Coefficient

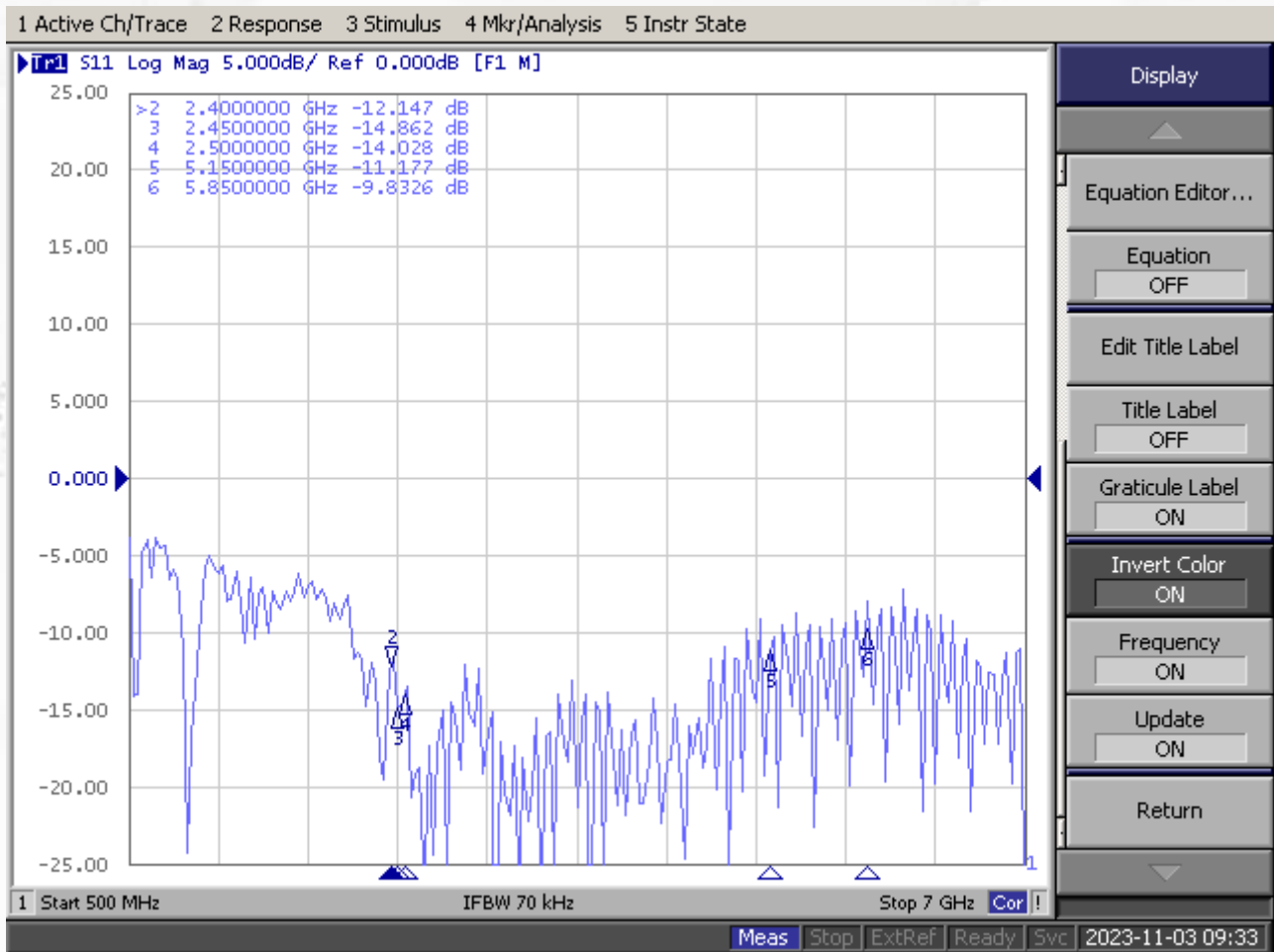

Maswell 5G 4X4 MIMO Antenna Screw Mount IP67 L Plate Mount Street Lamp

AN_Master_Cubic-4C-LP

Isolation

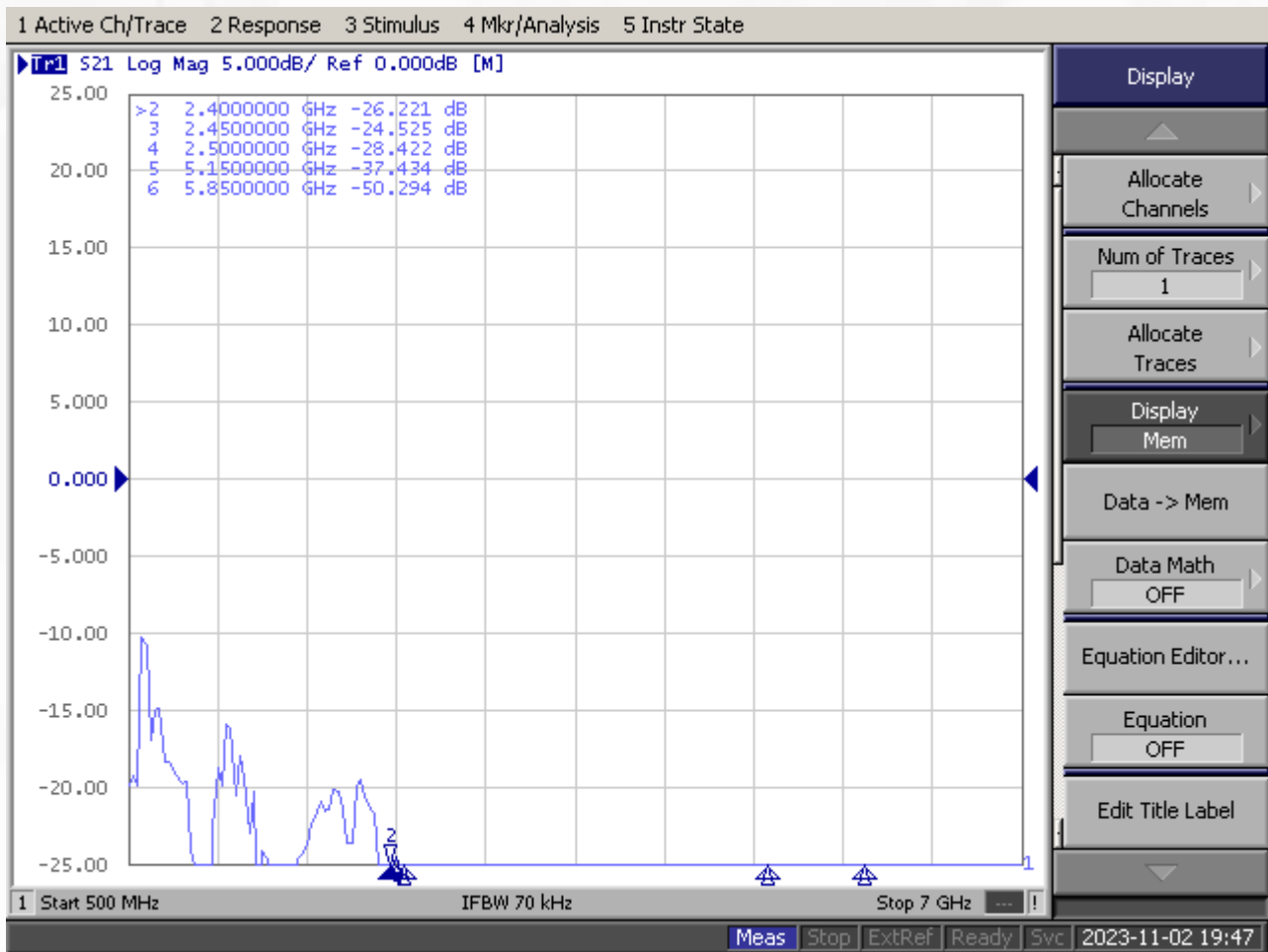

Maswell 5G 4X4 MIMO Antenna Screw Mount IP67 L Plate Mount Street Lamp

AN_Master_Cubic-4C-LP

Radiation Pattern 900MHz

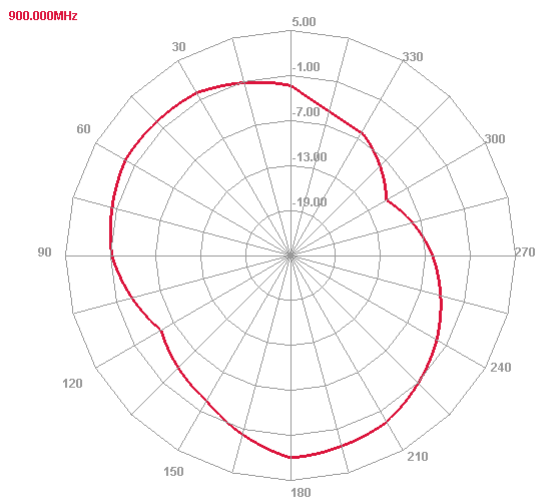

E plane

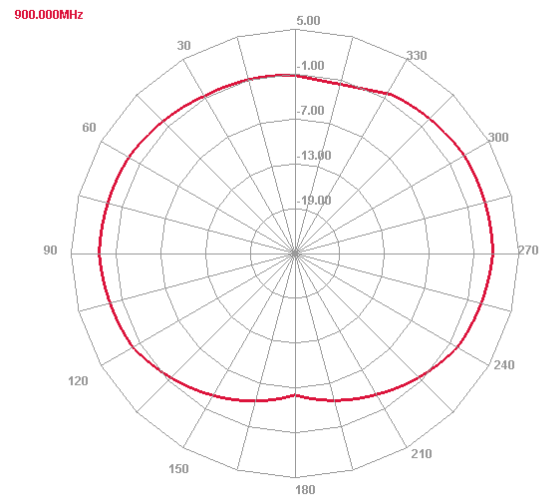

H plane

2400MHz

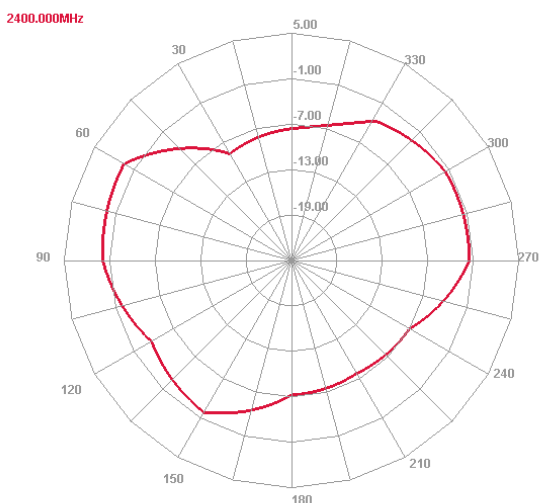

E plane

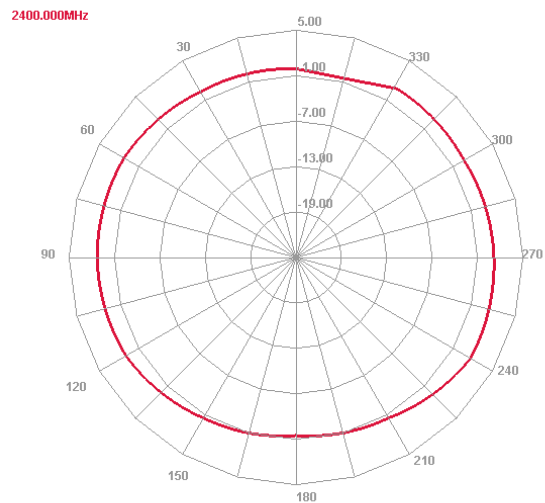

H plane

Maswell 5G 4X4 MIMO Antenna Screw Mount IP67 L Plate Mount Street Lamp

AN_Master_Cubic-4C-LP

Radiation Pattern 3500MHz

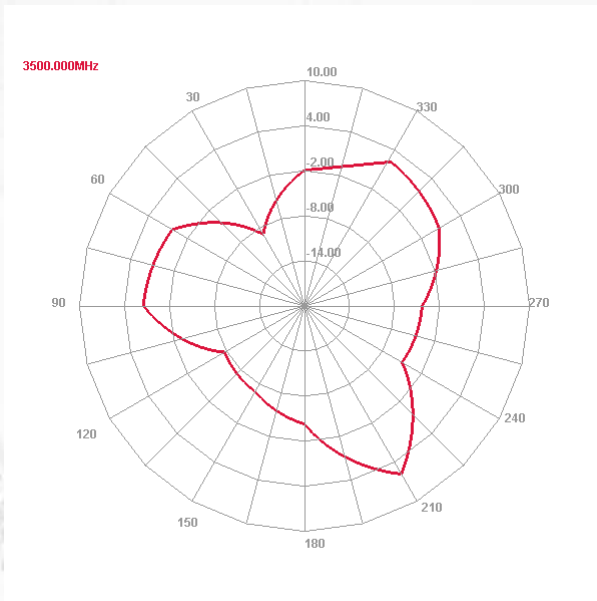

E plane

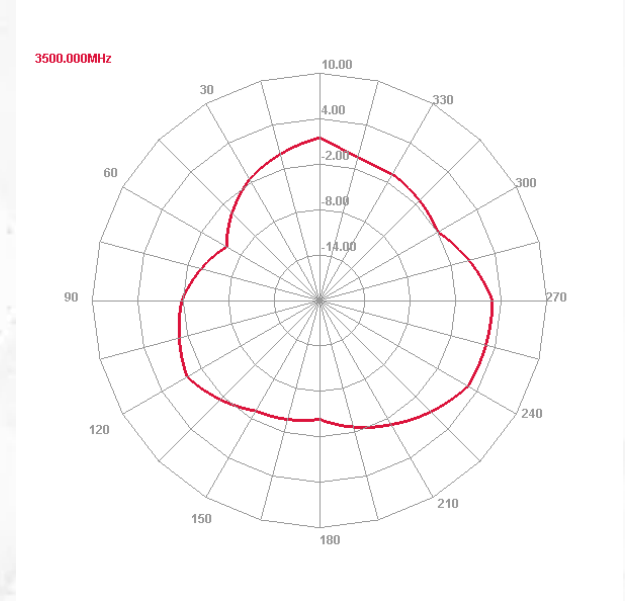

H plane

7100MHz

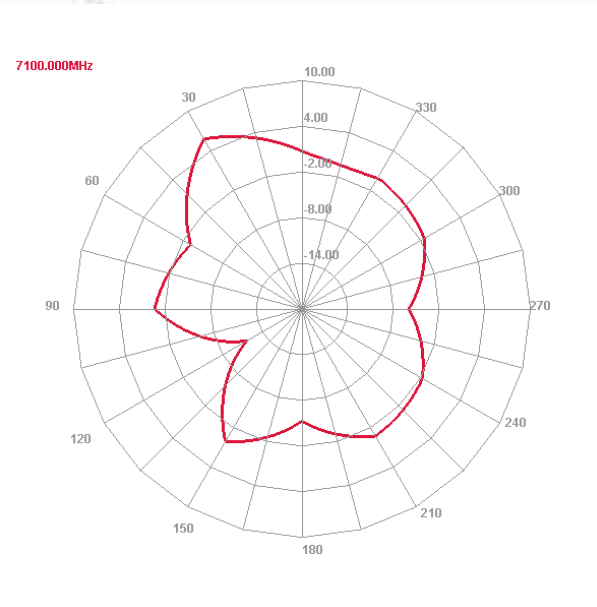

E plane

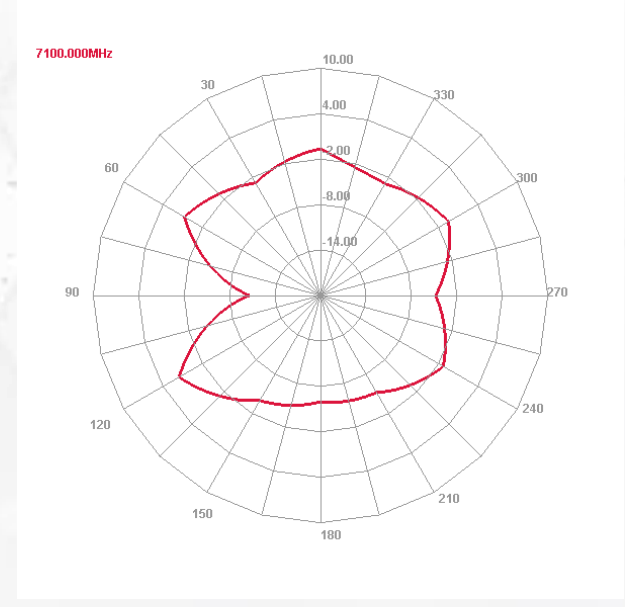

H plane