



## Short Form Catalog

**Microwave, Wireless and  
Broadband Components**

[www.aeroflex-inmet.com](http://www.aeroflex-inmet.com)



Attenuators  
Adapters  
Bias Tees  
DC Blocks  
Gain Equalizers  
Terminations

Company Profile .....	1	
<b>Attenuators</b> .....	2-8	<i>Catalog Notes</i>
<b>Impedance Matching Pads</b> .....	5	
<b>Terminations</b> .....	9-12	<i>The 2.9mm products shown herein are in fact 2.92mm components. Aeroflex / Inmet has elected to use 2.9mm as a "shorthand" designation for the 2.92mm standard.</i>
<b>Adapters</b> .....	13-17	
<b>DC Blocks</b> .....	18-19	
<b>Bias Tees</b> .....	20	<i>Components with SMP connectors will also mate with GPO™ products; and the SMPM products mate with GPPO™ components.</i>
<b>Equalizers</b> .....	21	
<b>Amplifiers, Opens, Shorts, Power Dividers, Detectors, Dust Caps</b> .....	22	<i>The trademarks "GPO™" and "GPPO™" appearing in this catalog are trademarks of Corning Gilbert Inc.</i>
How to Order.....	23	
About our Web Site .....	24	
Distribution.....	Inside Back Cover	

## How to use this catalog

This catalog is designed to give you a general description of the broad selection of products manufactured by Aeroflex / Inmet. When used in conjunction with our web site, you can view, print, or download detailed data sheets for each product in PDF format. Each sheet contains an outline drawing, electrical and mechanical specifications, as well as part number examples. It's easy:

1. Simply log on to [www.aeroflex-inmet.com](http://www.aeroflex-inmet.com).
2. Along the bottom of the home page is a section titled "search Inmet products by category".
3. Point and click on the product category of interest.
4. Select from the various options on the this screen and you will be directed to a view identical to the page you see in this catalog for the same product.
5. Point and click on the model of interest and a data sheet in PDF format will appear. You may view, print or download this PDF file for future reference.

## RoHS Statement

All standard catalog products designed by Aeroflex / Inmet shipped after July 1, 2006 conform to the requirements as specified in the Directive 2002/95/EC of the European Parliament and of the Council of 27 January 2003 and related Annex and Amendments on the Restriction of the Use of Certain Hazardous Substances in Electrical and Electronic Equipment (RoHS), with the exception of models 8812, 8820, and 8821 Bias Tees. For these models, please refer to the applicable data sheets found on our website. The information presented herein is believed to be accurate, reliable and is a result of review of numerous sources including vendor submitted data sheets and certifications.

Please note:

1. Equalizers are not considered standard catalog products for the purpose of this statement.
2. Some equalizer products may already be RoHS compliant. Please direct any questions to [sales@aeroflex-inmet.com](mailto:sales@aeroflex-inmet.com)
3. Non-compliant finished goods stock will be offered with a -701 designation added to the base model number. Please contact [sales@aeroflex-inmet.com](mailto:sales@aeroflex-inmet.com) for further details.

In 1975 Inmet Corporation entered the microwave component manufacturing arena to provide quality, precision-made components at reasonable prices. Shortly thereafter, the company's ability to develop and build custom-made components for special applications was recognized, earning the company a reputation for innovative, custom design capabilities and an ever-expanding product line.

Today, Aeroflex / Inmet continues to concentrate on new product development. Realizing that buyers seek companies who continuously bring new entries to their lineups rather than resting on their laurels, the company is at the forefront in tackling new design tasks. Our talented engineers specialize in building custom components for a variety of different specifications. Besides developing the world's shortest coaxial attenuator (0.700" in length), we have developed many other connector components – Type F, 7/16, 1.85mm, 2.9mm, 2.4mm, SMP, and SMPM – for various applications. As technologies change and market demands continue to push for higher and higher frequency components for use in new applications, Aeroflex / Inmet continues to extend the frequency capability of its entire product line.

The company has built on its name recognition for quality coaxial components and is striving to become the world's number one source for coaxial attenuators. Our components currently operate in the DC to 65 GHz frequency range, and consist of a myriad of connector types, with power handling capabilities from 1 to 300 watts. Our lineup of 3,000 variations of coaxial products include:

- Attenuators and Power Attenuators
- Terminations and Power Terminations
- Bias Tees
- DC Blocks
- Equalizers (fixed and adjustable)
- Adapters
- Amplifiers
- Detectors

Aeroflex / Inmet also zeros in on the design and manufacture of specific multi-component hybrid products such as "between series attenuators," combination "DC block/attenuators or terminations," and "bias passing attenuators" for more complex and sophisticated applications.

Yet, an ongoing part of our specialized commitment to customers is our vast array of off-the-shelf products. These products offer quality, selection, and just-in-time delivery of precision-made broadband, microwave and wireless components to buyers around the world.



Earning the "preferred supplier" designation from many buyers, the company is well known for reducing costs of its products while maintaining "first class performance." Featuring "on-demand" inventory of hundreds of standard catalog items, they can be ready for same-day shipment or overnight delivery. In addition, a partnership with Richardson Electronics offers customers worldwide the convenience and support of a full-service global distributor.

Since becoming an active participant in the broadband, RF, microwave and wireless industries, "Inmet" has attracted the attention of many companies and investors in the electronics arena. In 1994, a newly formed enterprise, MCE Technologies acquired Inmet Corporation as the first of several companies manufacturing microwave components and subsystems. In 2003, MCE Technologies became a part of Aeroflex Microelectronics Solutions, a division of Aeroflex, a manufacturer of high performance test and measurement and microelectronic solutions for the aerospace, defense and broadband communications markets.

## Model A/AH SMA

SHORT: 0.86"  
Nominal Length

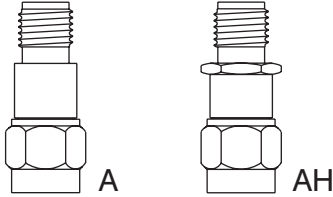

**Models 2A, 4A, 6A, 12A, 18A, 23A  
2AH, 4AH, 6AH, 12AH, 18AH, 23AH**  
Frequency Range..... DC to 23GHz  
Available Values..... 0-10, 12, 15, 20, 30dB  
Accuracy of Attenuation:  
0 through 6dB.....±0.3dB maximum  
7 through 20dB.....±0.5dB maximum  
21 through 30dB.....±0.75dB maximum  
VSWR:  
DC to 4GHz.....1.15:1 maximum  
4GHz to 8GHz.....1.20:1 maximum  
8GHz to 12.4GHz.....1.25:1 maximum  
12.4GHz to 18GHz.....1.35:1 maximum  
18GHz to 23GHz.....1.40:1 maximum  
Overall length in inches

	0-12dB	13-30dB
M/F	.86 ± .03	.99 ± .03
M/M	.98 ± .03	1.11 ± .03
F/F	.87 ± .03	1.00 ± .03

Complete Specification Sheet Available

## Model C/CH SMA

SHORTER: 0.76"  
Nominal Length

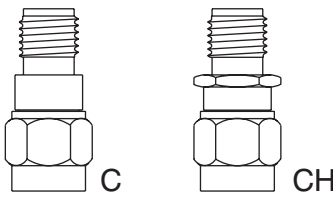

**Models 2C, 4C, 6C, 12C, 18C  
2CH, 4CH, 6CH, 12CH, 18CH**  
Frequency Range..... DC to 18GHz  
Available Values..... 0-10, 12, 15, 20, 30dB  
Accuracy of Attenuation:  
0 through 6dB.....±0.3dB maximum  
7 through 20dB.....±0.5dB maximum  
21 through 30dB.....±0.75dB maximum  
VSWR:  
DC to 4GHz.....1.15:1 maximum  
4GHz to 8GHz.....1.20:1 maximum  
8GHz to 12.4GHz.....1.25:1 maximum  
12.4GHz to 18GHz.....1.35:1 maximum  
Overall length in inches

	0-12dB	13-30dB
M/F	.76 ± .03	.89 ± .03

Complete Specification Sheet Available

## Model DH SMA

SHORTEST: 0.70"  
Nominal Length



**Models 2DH, 6DH, 12DH,  
18DH, 23DH** DH

Frequency Range..... DC to 23GHz  
Available Values..... 0-10, 12, 15, 20, 30, 40dB  
Accuracy of Attenuation:  
0 through 6dB.....±0.3dB maximum  
7 through 20dB.....±0.5dB maximum  
21 through 30dB..... ±0.7dB maximum  
31 through 35dB..... ±1.0dB maximum  
36 through 40dB..... ±1.5dB maximum  
VSWR:  
DC to 4GHz.....1.15:1 maximum  
4GHz to 8GHz.....1.20:1 maximum  
8GHz to 12.4GHz.....1.25:1 maximum  
12.4GHz to 23GHz.....1.35:1 maximum  
Overall length in inches

	0-20dB	21-40dB
M/F	.70 ± .03	.83 ± .03
M/M	.76 ± .03	.89 ± .03
F/F	.64 ± .03	.77 ± .03

Complete Specification Sheet Available

## Model AHC SMA

0.86"  
Nominal Length

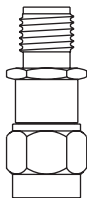

**Model AHC**  
Frequency Range..... DC to 6 GHz  
Available Values..... 0-10, 12, 15, 20, 30dB  
Accuracy of Attenuation:  
1 through 10dB.....±0.5dB maximum  
12, 15, 20dB.....±0.7dB maximum  
30dB.....±0.9dB maximum  
VSWR:  
DC to 6 GHz.....1.20:1 maximum  
Overall length in inches

	0-12dB	15/20/30dB
M/F	.86 ± .02	.99 ± .02

Complete Specification Sheet Available

## Model B SMA

1.21"  
Nominal Length

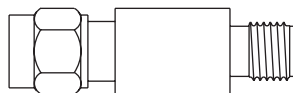

**Models 2B, 6B, 12B,18B**  
Frequency Range..... DC to 18GHz  
Available Values..0-10, 12, 15, 20, 30, 40, 50, 60dB  
Accuracy of Attenuation:  
0 through 6dB.....±0.3dB maximum  
7 through 20dB.....±0.5dB maximum  
21 through 30dB.....±0.75dB maximum  
31 through 60dB.....±1.50dB maximum  
VSWR:  
DC to 4GHz.....1.15:1 maximum  
4GHz to 8GHz.....1.20:1 maximum  
8GHz to 12.4GHz.....1.25:1 maximum  
12.4GHz to 18GHz.....1.35:1 maximum  
Overall length in inches

	0-30 & 40dB	31-60dB
M/F	1.21 ± .03	1.49 ± .03
M/M	1.33 ± .03	1.62 ± .03
F/F	1.06 ± .03	1.35 ± .03

Complete Specification Sheet Available

## 9000 Series General Purpose 18GHz SMA Attenuators

**Models 9023, 9024, 9025**  
Available Values 0-10, 12, 15, 20, 30, 40, 50, 60dB  
Accuracy of Attenuation:  
0 through 12dB.....±0.75dB maximum  
13 through 20dB.....±1.00dB maximum  
21 through 40dB.....±1.50dB maximum  
41 through 60dB.....±2.00dB maximum  
**Models 9026 through 9031**  
Available Values..... 0-10, 12, 15, 20,30dB  
Accuracy of Attenuation:  
0 through 12dB.....±0.75dB maximum  
13 through 20dB..... ±1.00dB maximum  
21 through 30dB..... ±1.50dB maximum  
VSWR: (All Models)  
DC to 4GHz.....1.20:1 maximum  
4GHz to 12.4GHz..... 1.40:1 maximum  
12.4GHz to 18GHz.....1.60:1 maximum  
Overall length in inches

Model	Configuration	Length (inches)
9023	M/F no hex	1.51
9024	M/M no hex	1.65
9025	F/F no hex	1.37
9026	M/F no hex	1.01
9027	M/M no hex	1.14
9028	F/F no hex	1.02
9029	M/F w/hex	1.01
9030	M/M w/hex	1.14
9031	F/F w/hex	1.02

Complete Specification Sheet Available

## SMP, GPO™ Series

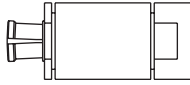

### Models 18G, 18P

Frequency Range.....DC to 18GHz  
 Available Values.....0-12, 20 and 30dB  
 Accuracy of Attenuation:  
 1 through 6dB.....±0.4dB maximum  
 7 through 12dB.....±0.6dB maximum  
 20 and 30dB.....±0.8dB maximum  
 VSWR:  
 DC to 8GHz.....1.25:1 maximum  
 8GHz to 18GHz.....1.35:1 maximum

### Models 26G, 26P

Frequency Range.....DC to 26GHz  
 Available Values.....0-12, 20 and 30dB  
 Accuracy of Attenuation:  
 DC-26.5GHz  
 3 and 6dB.....±0.4  
 10dB.....±0.6  
 20 and 30dB.....±0.8  
 VSWR:  
 DC to 26.5GHz.....1.45:1 maximum

Note: GPO™ and SMP male connectors are available in full and limited detent.

Complete Specification Sheet Available

## High Frequency 2.9mm Series

DC-26.5 GHz  
and DC-40 GHz

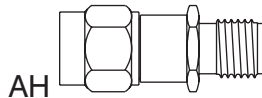
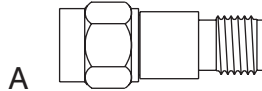

### MODELS 26A AND 26AH

Frequency Range..... DC to 26.5GHz  
 Available Values..... 0, 3, 6, 10, 20, 30dB  
 VSWR:  
 DC to 18GHz.....1.30:1 maximum  
 18GHz to 26.5GHz.....1.40:1 maximum

### MODELS 40A, 40AH

Frequency Range..... DC to 40GHz  
 Available Values.....0, 3, 6, 10, 20, 30dB  
 VSWR:  
 DC to 40GHz..... 1.40:1 maximum

### Overall length in inches

	0-12dB	13-30dB
26.5GHz		
M/F	.88 ± .05	1.01 ± .05
40GHz	0-30dB	
M/F	.88 ± .05	

Complete Specification Sheet Available

## High Frequency 2.4mm Series

DC-40 GHz  
and DC-50 GHz



### Models 40EH and 50EH

Frequency Range..... DC to 50GHz  
 Available Values..... 0, 3, 6, 10, 20, 30dB  
 Accuracy of Attenuation:  
**DC - 26.5 GHz**  
 0 through 10dB.....±0.5dB maximum  
 20 & 30dB.....±0.75dB maximum  
**26.5 - 40 GHz**  
 0 through 10dB.....±1.0dB maximum  
 20 & 30dB.....±1.25dB maximum  
**40 - 50 GHz**  
 0 through 10dB.....±1.5dB maximum  
 20 & 30dB.....±2.0dB maximum  
 VSWR:  
 DC to 26.5 GHz.....1.35:1 maximum  
 26.5 to 40 GHz.....1.60:1 maximum  
 40 to 50 GHz.....1.75:1 maximum

Complete Specification Sheet Available

## N Series

(50 and 75 Ohms)

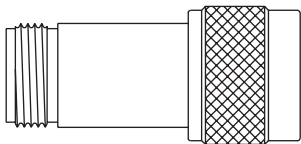

### 50 Ohms

#### Nickel Plated Brass

#### Models 9070, 9071, 9072

Frequency Range.....DC to 2GHz  
 Available Values.....0-10, 12, 15, 20, 30, 40, 50 and 60dB  
 VSWR:  
 DC to 2GHz.....1.25:1 maximum

#### Stainless Steel Models 2N, 6N, 12N, 18N

Frequency Range..... DC to 18GHz  
 Available Values.....0-10, 12, 15, 20, 30, 40, 50 and 60dB  
 VSWR:  
 DC to 4GHz.....1.15:1 maximum  
 4GHz to 8GHz.....1.20:1 maximum  
 8GHz to 12.4GHz.....1.25:1 maximum  
 12.4GHz to 18GHz.....1.35:1 maximum

### 75 Ohms

#### Model 4N-XX/75

Frequency Range.....DC to 4GHz  
 Available Values.....1, 2, 3, 6, 10, 20 and 30dB  
 VSWR.....1.30:1 maximum

Complete Specification Sheet Available

## TNC Series

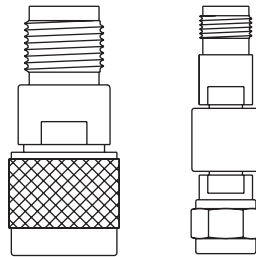

### Model 9036 (Nickel Plated Brass)

Frequency Range..... DC to 12.4GHz  
 Available Values...0-10, 12, 15, 20, 30 & 40dB

### Models 12T, 18T (Stainless Steel)

Frequency Range..... DC to 18GHz  
 Available Values 0-10, 12, 15, 20, 30, 40, 50, 60dB  
 Accuracy of Attenuation:  
 0 through 6dB.....±0.3dB maximum  
 7 through 20dB.....±0.5dB maximum  
 30dB.....±0.75dB maximum  
 40dB.....±1.0dB maximum  
 50 & 60dB.....±1.50dB maximum\*  
 VSWR:  
 DC to 4GHz.....1.15:1 maximum  
 4GHz to 8GHz.....1.20:1 maximum  
 8GHz to 12.4GHz.....1.25:1 maximum  
 12.4GHz to 18GHz.....1.35:1 maximum\*

\*12T and 18T only

Complete Specification Sheet Available

## BNC Series

(50 and 75 Ohms)

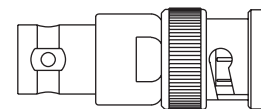

### 50 Ohms

#### Model 9073

Frequency Range..... DC to 2GHz  
 Available Values..... 0-10, 12, 15, 20 & 30 dB  
 Power..... 1 Watt  
 VSWR:  
 DC to 2GHz.....1.20:1 maximum

#### Model 9033

Frequency Range..... DC to 4GHz  
 Available Values..... 0-10, 12, 15, 20, 30dB  
 Power..... 2 Watts  
 VSWR:  
 DC to 4GHz.....1.25:1 maximum

### 75 Ohms

#### Model 9033-XX/75

Frequency Range..... DC to 4GHz  
 Available Values..... 0, 3, 6, 10, 20 & 30dB  
 Power..... 2 Watts  
 VSWR:  
 DC to 1GHz.....1.10:1 maximum  
 1GHz to 2GHz.....1.20:1 maximum  
 2GHz to 4GHz.....1.35:1 maximum

Complete Specification Sheet Available



## Attenuators—Power Handling vs. Frequency vs. Connector Type

GHz ▶	DC-1.5	DC-2.5	DC-4	DC-6	DC-7.5	DC-12.4	DC-18	DC-23	DC-26.5	DC-40	DC-50
<b>F 75Ω</b>	2W	2W									
<b>7/16</b>	300W	300W	100W	100W	50W						
<b>BNC</b>	300W	300W	100W								
<b>N</b>	300W	300W	100W	100W	50W	50W	50W				
<b>TNC</b>	300W	300W	100W	100W	50W	50W	50W				
<b>SMA</b>	300W	300W	100W	100W	50W	50W	50W	2W			
<b>SMB</b>	2W	2W	2W	2W							
<b>2.9mm</b>	2W	2W	2W	2W	2W	2W	2W	2W	2W	.5W	
<b>GPO™/SMP</b>	2W	2W	2W	2W	2W	2W	2W	2W	2W		
<b>2.4mm</b>	.5W	.5W	.5W	.5W	.5W	.5W	.5W	.5W	.5W	.5W	.5W

Power handling capabilities shown are MAXIMUM for the respective frequencies and connector types. Contact factory for specific lower power vs. frequency applications.

### MODEL NO.    FREQ. (GHz)    CONNECTOR    VSWR    ATTN (dB)

*.5 Watt and 2 Watt Attenuators, SMA, General Purpose, 2.9mm, 2.4mm\**

2A, 2AH	2.5	SMA-M/F, M/M, F/F	1.15:1	0-10,12,15,20,30
2B	2.5	SMA-M/F, M/M, F/F	1.15:1	0-10,12,15,20,30,40,50,60
2C, 2CH	2.5	SMA-M/F	1.15:1	0-10,12,15,20,30
2DH	2.5	SMA-M/F, M/M, F/F	1.15:1	0-10,12,15,20,30,40
4A, 4AH	4	SMA-M/F, M/M, F/F	1.15:1	0-10,12,15,20,30
6A, 6AH	6	SMA-M/F, M/M, F/F	1.20:1	0-10,12,15,20,30
AHC	6	SMA-M/F	1.20:1	1-10,12,15,20,30
6B	6	SMA-M/F, M/M, F/F	1.20:1	0-10,12,15,20,30,40,50,60
6C, 6CH	6	SMA-M/F	1.20:1	0-10,12,15,20,30
6DH	6	SMA-M/F, M/M, F/F	1.20:1	0-10,12,15,20,30,40
12A,12AH	12.4	SMA-M/F, M/M, F/F	1.25:1	0-10,12,15,20,30
12B	12.4	SMA-M/F, M/M, F/F	1.25:1	0-10,12,15,20,30,40,50,60
12C, 12CH	12.4	SMA-M/F	1.25:1	0-10,12,15,20,30
12DH	12.4	SMA-M/F, M/M, F/F	1.25:1	0-10,12,15,20,30,40
18A, 18AH	18	SMA-M/F, M/M, F/F	1.35:1	0-10,12,15,20,30
9026, 9027, 9028 (Style A)	18	SMA-M/F, M/M, F/F	1.60:1	0-10,12,15,20,30
9029, 9030, 9031 (Style AH)	18	SMA-M/F, M/M, F/F	1.60:1	0-10,12,15,20,30
18B	18	SMA-M/F, M/M, F/F	1.35:1	0-10,12,15,20,30,40,50,60
9023, 9024, 9025 (Style B)	18	SMA-M/F, M/M, F/F	1.60:1	0-10,12,15,20,30,40,50,60
18C, 18CH	18	SMA-M/F	1.35:1	0-10,12,15,20,30
18DH	18	SMA-M/F, M/M, F/F	1.35:1	0-10,12,15,20,30,40
23A, 23AH	23	SMA-M/F, M/M, F/F	1.40:1	0-10,12,15,20,30
23DH	23	SMA-M/F, M/M, F/F	1.35:1	0-10,12,15,20,30
26A, 26AH	26.5	2.9mm-M/F	1.40:1	0,3,6,10,20,30
40A, 40AH (0.5W)	40	2.9mm-M/F	1.40:1	0,3,6,10,20,30
40EH (0.5W)	40	2.4mm-M/F	1.60:1	0,3,6,10,20,30
50EH (0.5W)	50	2.4mm-M/F	1.75:1	0,3,6,10,20,30

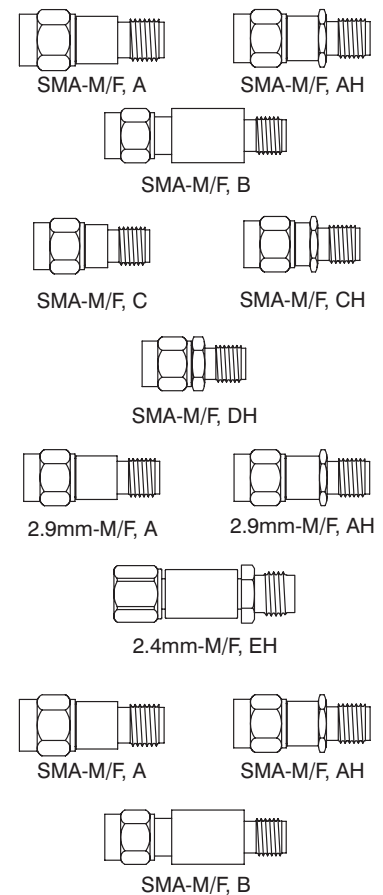

H=with Hex

\* See pages 2 and 3 for more detailed specifications.

# Attenuator Reference Guide



MODEL NO.	FREQ. (GHz)	CONNECTOR	VSWR	ATTN (dB)
<b>2 Watt Attenuators, N, BNC, SMB, TNC, GPO™, SMP</b>				
9070, 9071, 9072	2.5	N-M/F, M/M, F/F	1.25:1	0-10,12,15,20,30,40,50,60
2N	2.5	N-M/F, M/M, F/F	1.15:1	0-10,12,15,20,30,40,50,60
6N	6	N-M/F, M/M, F/F	1.20:1	0-10,12,15,20,30,40,50,60
12N	12.4	N-M/F, M/M, F/F	1.25:1	0-10,12,15,20,30,40,50,60
18N	18	N-M/F, M/M, F/F	1.35:1	0-10,12,15,20,30,40,50,60
9073	2	BNC-M/F	1.20:1	0-10,12,15,20,30
9033	4	BNC-M/F	1.25:1	0-10,12,15,20,30
9014, 9015, 9016	4	BNC-M/F, M/M, F/F	1.25:1	0-10,12,15,20,30,40,50,60
2051	12.4	BNC-M/F	1.35:1	3,6,10,20,30
9056	4	SMB-M/F, M/M, F/F	1.20:1	0-10,12,15,20,30
9042	2.5	TNC-M/F	1.25:1	0-10,12,15,20,30,40
9043	6	TNC-M/F	1.25:1	0-10,12,15,20,30,40
9036	12.4	TNC-M/F	1.25:1	0-10,12,15,20,30,40
12T	12.4	TNC-M/F, M/M, F/F	1.25:1	0-10,12,15,20,30,40,50,60
18T	18	TNC-M/F, M/M, F/F	1.35:1	0-10,12,15,20,30,40,50,60
18G	18	GPO-M/F, M/M, F/F	1.35:1	0-12,20,30
26G	26.5	GPO-M/F, M/M, F/F	1.45:1	0-12,20,30
18P	18	SMP-M/F, M/M, F/F	1.35:1	0-12,20,30
26P	26.5	SMP-M/F, M/M, F/F	1.45:1	0-12,20,30

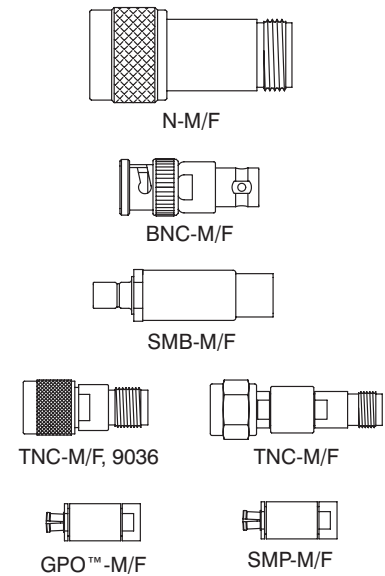

Note: GPO™ and SMP male connectors are available in full and limited detent.

## 2 Watt 75 Ohm Attenuators

3F	3	F-M/F, M/M, F/F	1.15:1	3,6,10,15,20,30
9033-XX/75	4	BNC-M/F	1.35:1	0,3,6,10,20,30
4N-XX/75	4	N-M/F	1.30:1	1,2,3,6,10,20,30



## 1 Watt Impedance Matching Pads (50 to 75 Ohm, 50 to 93 Ohm)

9033-50/75	1	BNC-M/F	1.20:1	5.7
9033-75/50	1	BNC-M/F	1.20:1	5.7
9033-50/93	0.1	BNC-M/F	1.10:1	7.2
9033-93/50	0.1	BNC-M/F	1.10:1	7.2
9070-50/75	3	N-M/F	1.35:1	5.7
9070-75/50	3	N-M/F	1.35:1	5.7
9076-50/75	3	SMA-M/F-F	1.25:1	5.7
9077-50/75	3	N-M/F-F	1.25:1	5.7
9078-50/75	3	BNC-M/F-F	1.25:1	5.7
9079-50/75	3	SMA-F/F-M	1.25:1	5.7
9080-50/75	3	SMA-M/F-M	1.25:1	5.7
9082-50/75	3	N-F/F-M	1.25:1	5.7
9083-50/75	3	N-M/F-M	1.25:1	5.7
9084-50/75	3	TNC-F/F-M	1.25:1	5.7
9085-50/75	3	TNC-M/F-M	1.25:1	5.7
9086-50/75	3	BNC-F/F-M	1.25:1	5.7
9087-50/75	3	BNC-M/F-M	1.25:1	5.7
9088-50/75	3	SMA-F/F-F	1.25:1	5.7
9089-50/75	3	N-F/F-F	1.25:1	5.7
9090-50/75	3	BNC-F/F-F	1.25:1	5.7
9091-50/75	3	TNC-M/F-F	1.25:1	5.7
9092-50/75	3	TNC-F/F-F	1.25:1	5.7

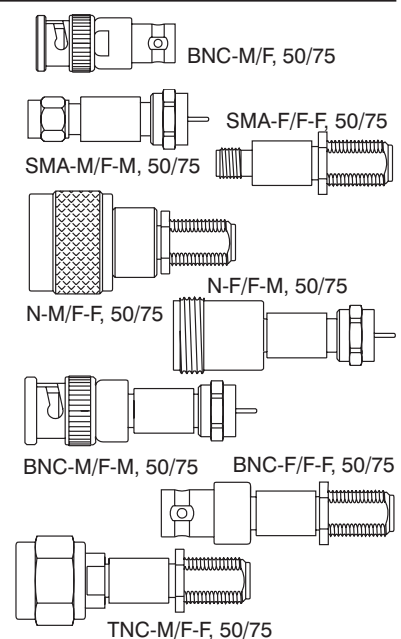

## 2 Watt DC Bias Passing RF Attenuators

9093-N	0.50-2	N-M/F	1.35:1	4,6,10,15,20,25
9093-SMA	0.50-2	SMA-M/F	1.35:1	4,6,10,15,20,25
9093-TNC	0.50-2	TNC-M/F	1.35:1	4,6,10,15,20,25
9093-F	0.50-2	F-M/F	75Ω	1.45:1 3,4,6,7,8,9,10,11,20
9095-N	0.05-3	N-M/F	1.35:1	3,4,6,10,15,20,25
9095-SMA	0.05-3	SMA-M/F	1.35:1	3,4,6,10,15,20,25
9095-TNC	0.05-3	TNC-M/F	1.35:1	3,4,6,10,15,20,25

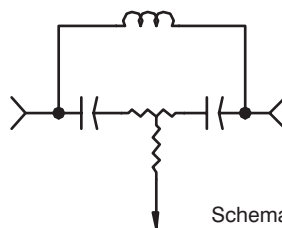

Schematic Diagram

MODEL NO.	FREQ. (GHz)	CONNECTOR	VSWR	ATTN (dB)
<b>2 Watt DC Blocking Attenuators (Also See DC Block Section, page 19)</b>				
8516S-XX	0.01-2	SMA-M/F, M/M, F/F	1.15:1	0-10,12,15,20
8516N-XX	0.01-2	N-M/F, M/M, F/F	1.15:1	0-10,12,15,20
8516-XX	0.01-2	TNC-M/F, M/M, F/F	1.15:1	0-10,12,15,20
8528A-XX	0.01-2	F-M/F 75Ω	1.35:1	0-10,12,15,20

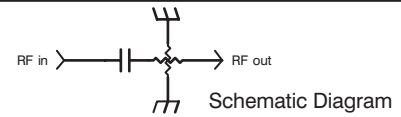

<b>1 and 2 Watt Flange Mount Attenuators</b>				
2004, 2005, 2006	18	SMA-M/F, M/M, F/F	1.35:1	0-10,12,15,20,30
2046 (1W)	18	SMA-F/PIN 4-hole	1.15:1	0-10,12,15,20
2059 (1W)	12.4	SMA-F/PIN 2-hole	1.25:1	0-10,12,15,20
2067 (1W)	3	SMA-F/PIN 4 hole	1.25:1	0-10,12,15,20
2077 (1W)	12.4	SMA-F/PIN 2 hole	1.25:1	0-10,12,15,20
2086	18	SMA-F/PIN 4 hole	1.50:1	0-12
2087	18	SMA-M/PIN 4 hole	1.50:1	0-12
2186S	18	SMA-F/PIN 2 hole	1.50:1	0-12
2187S	18	SMA-M/PIN 2 hole	1.50:1	0-12
2086K	18	2.9mm-F/PIN 4 hole	1.50:1	0-12
2087K	18	2.9mm-M/PIN 4 hole	1.50:1	0-12
2112F, 2112M	18	2.9mm/PIN 2 hole	1.50:1	0-12

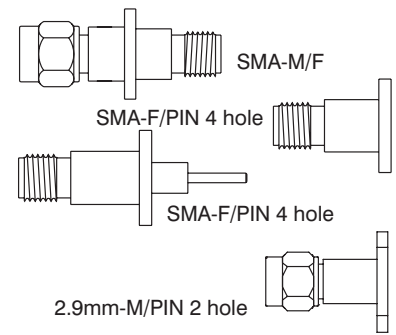

<b>Adapting Attenuators, Between Series</b>				
2028	18	N/M-SMA/M	1.30:1	0-10,12,15,20
2029	18	N/M-SMA/F	1.30:1	0-10,12,15,20
2030	18	N/F-SMA/M	1.30:1	0-10,12,15,20
2031	18	N/F-SMA/F	1.30:1	0-10,12,15,20

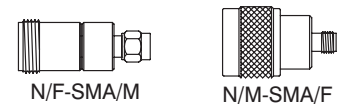

<b>Calibrated Attenuator Sets</b>				
9401	18	N		3,6,10,20
9402	12.4	N		3,6,10,20
9403	18	SMA (A Style)		3,6,10,20
9404	12.4	SMA (A Style)		3,6,10,20
9405	18	N		1,3,6,10,20,30
9406	12.4	N		1,3,6,10,20,30
9407	18	SMA (A Style)		1,3,6,10,20,30
9408	12.4	SMA (A Style)		1,3,6,10,20,30
9473	23	SMA (DH Style)		1,3,6,10,20,30
9411	26.5	2.9mm (A Style)		3,6,10,20
9412	26.5	2.9mm (A Style)		1,3,6,10,20,30
9413 (0.5W)	40	2.9mm (A Style)		3,6,10,20
9414 (0.5W)	40	2.9mm (A Style)		1,3,6,10,20,30
9415 (0.5W)	40	2.4mm (EH Style)		3,6,10,20
9416 (0.5W)	50	2.4mm (EH Style)		3,6,10,20

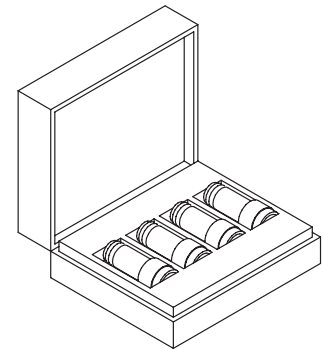

Set 9401

<b>5 Watt Attenuators, Convection Cooled</b>				
2N5W	2.5	N-M/F, M/M, F/F	1.15:1	0-12,15,20,30,40
4N5W	4	N-M/F, M/M, F/F	1.15:1	0-12,15,20,30,40
6N5W	6	N-M/F, M/M, F/F	1.20:1	0-12,15,20,30,40
12N5W	12.4	N-M/F, M/M, F/F	1.25:1	0-10,12,15,20,30,40
18N5W	18	N-M/F, M/M, F/F	1.35:1	0-10,12,15,20,30,40
2BNC5W	2.5	BNC-M/F, M/M, F/F	1.25:1	0-12,15,20,30,40
4BNC5W	4	BNC-M/F, M/M, F/F	1.25:1	0-12,15,20,30,40
2D5W	2.5	7/16 DIN-M/F, M/M, F/F	1.25:1	0-12,15,20,30,40
4D5W	4	7/16 DIN-M/F, M/M, F/F	1.25:1	0-12,15,20,30,40
7D5W	7.5	7/16 DIN-M/F, M/M, F/F	1.45:1	0-12,15,20,30,40
4B5W	4	SMA-M/F, M/M, F/F	1.15:1	0-12,15,20,30,40
6B5W	6	SMA-M/F, M/M, F/F	1.20:1	0-12,15,20,30,40
12B5W	12.4	SMA-M/F, M/M, F/F	1.25:1	0-10,12,15,20,30,40
18B5W	18	SMA-M/F, M/M, F/F	1.35:1	0-10,12,15,20,30,40
6T5W	6	TNC-M/F, M/M, F/F	1.20:1	0-12,15,20,30,40
12T5W	12.4	TNC-M/F, M/M, F/F	1.25:1	0-10,12,15,20,30,40
18T5W	18	TNC-M/F, M/M, F/F	1.35:1	0-10,12,15,20,30,40

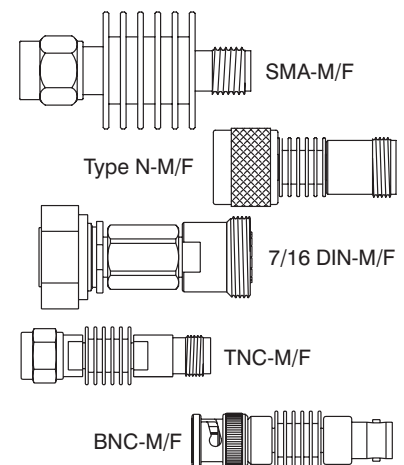



# Attenuator Reference Guide

MODEL NO.	FREQ. (GHz)	CONNECTOR	VSWR	ATTN (dB)
<b>10 Watt Attenuators, Convection Cooled</b>				
2B10W	2.5	SMA-M/F, M/M, F/F	1.20:1	0-10,12,20,30,40
6B10W	6	SMA-M/F, M/M, F/F	1.20:1	0-10,12,20,30,40
12B10W	12.4	SMA-M/F, M/M, F/F	1.30:1	0-10,12,20,30,40
18B10W	18	SMA-M/F, M/M, F/F	1.40:1	0-10,12,20,30,40
2N10W	2.5	N-M/F, M/M, F/F	1.20:1	0-10,12,20,30,40
6N10W	6	N-M/F, M/M, F/F	1.20:1	0-10,12,20,30,40
12N10W	12.4	N-M/F, M/M, F/F	1.30:1	0-10,12,20,30,40
18N10W	18	N-M/F, M/M, F/F	1.40:1	0-10,12,20,30,40
2BNC10W	2.5	BNC-M/F, M/M, F/F	1.25:1	0-10,12,15,20,30
4BNC10W	4	BNC-M/F, M/M, F/F	1.25:1	0-10,12,15,20,30
2T10W	2.5	TNC-M/F, M/M, F/F	1.20:1	0-10,12,20,30,40
6T10W	6	TNC-M/F, M/M, F/F	1.20:1	0-10,12,20,30,40
12T10W	12.4	TNC-M/F, M/M, F/F	1.30:1	0-10,12,20,30,40
18T10W	18	TNC-M/F, M/M, F/F	1.40:1	0-10,12,20,30,40
2D10W	2.5	7/16 DIN, M/F, M/M, F/F	1.25:1	0-10,12,20,30,40
4D10W	4	7/16 DIN, M/F, M/M, F/F	1.25:1	0-10,12,20,30,40
7D10W	7.5	7/16 DIN-M/F, M/M, F/F	1.45:1	0-10,12,20,30,40
<b>20 Watt Attenuators, Convection Cooled</b>				
2B20W	2.5	SMA-M/F, M/M, F/F	1.20:1	0,3,6,10,20,30,40
6B20W	6	SMA-M/F, M/M, F/F	1.20:1	0,3,6,10,20,30,40
12B20W	12.4	SMA-M/F, M/M, F/F	1.30:1	0,3,6,10,20,30,40
18B20W	18	SMA-M/F, M/M, F/F	1.40:1	0,3,6,10,20,30,40
2066 w/mounting holes	12.4	SMA-M/F, M/M, F/F	1.30:1	0,3,6,10,20,30,40
2099 w/mounting holes	18	SMA-M/F, M/M, F/F	1.40:1	0,3,6,10,20,30,40
2N20W	2.5	N-M/F, M/M, F/F	1.20:1	0,3,6,10,20,30,40
2044	4	N-M/F	1.15:1	0-10, 20, 30
6N20W	6	N-M/F, M/M, F/F	1.20:1	0,3,6,10,20,30,40
12N20W	12.4	N-M/F, M/M, F/F	1.30:1	0,3,6,10,20,30,40
2069 w/mounting holes	12.4	N-M/F, M/M, F/F	1.30:1	0,3,6,10,20,30,40
2100 w/mounting holes	18	N-M/F, M/M, F/F	1.40:1	0,3,6,10,20,30,40
18N20W	18	N-M/F, M/M, F/F	1.40:1	0,3,6,10,20,30,40
2BNC20W	2.5	BNC-M/F, M/M, F/F	1.25:1	0,3,6,10,20,30,40
4BNC20W	4	BNC-M/F, M/M, F/F	1.25:1	0,3,6,10,20,30,40
2T20W	2.5	TNC-M/F, M/M, F/F	1.20:1	0,3,6,10,20,30,40
6T20W	6	TNC-M/F, M/M, F/F	1.20:1	0,3,6,10,20,30,40
12T20W	12.4	TNC-M/F, M/M, F/F	1.30:1	0,3,6,10,20,30,40
18T20W	18	TNC-M/F, M/M, F/F	1.40:1	0,3,6,10,20,30,40
2D20W	2.5	7/16 DIN-M/F, M/M, F/F	1.25:1	0,3,6,10,20,30,40
4D20W	4	7/16 DIN-M/F, M/M, F/F	1.25:1	0,3,6,10,20,30,40
7D20W	7.5	7/16 DIN-M/F, M/M, F/F	1.45:1	0,3,6,10,20,30,40
<b>20 Watt Attenuators, Conduction Cooled</b>				
9097	2.5	SMA-M/F, M/M, F/F	1.25:1	0,3,6,10,20,30,40
9098	18	SMA-M/F, M/M, M/F	1.40:1	0,3,6,10,20,30,40
<b>25 Watt Attenuators, Convection Cooled</b>				
2B25W	2.5	SMA-M/F, M/M, F/F	1.20:1	0,3,6,10,20,30,40
2N25W	2.5	N-M/F, M/M, F/F	1.20:1	0,3,6,10,20,30,40
2BNC25W	2.5	BNC-M/F, M/M, F/F	1.25:1	0,3,6,10,20,30,40
4BNC25W	4	BNC-M/F, M/M, F/F	1.25:1	0,3,6,10,20,30,40
2T25W	2.5	TNC-M/F, M/M, F/F	1.20:1	0,3,6,10,20,30,40
2D25W	2.5	7/16 DIN-M/F, M/M, F/F	1.25:1	0,3,6,10,20,30,40
4D25W	4	7/16 DIN-M/F, M/M, F/F	1.25:1	0,3,6,10,20,30,40
7D25W	7.5	7/16 DIN-M/F, M/M, F/F	1.45:1	0,3,6,10,20,30,40
6X25W	6	SMA, N, TNC	1.20:1	0,3,6,10,20,30,40
12X25W	12.4	SMA, N, TNC	1.30:1	0,3,6,10,20,30,40
18X25W	18	SMA, N, TNC	1.40:1	0,3,6,10,20,30,40

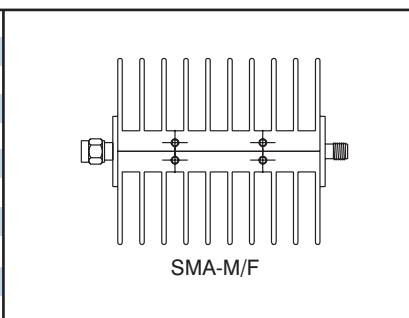
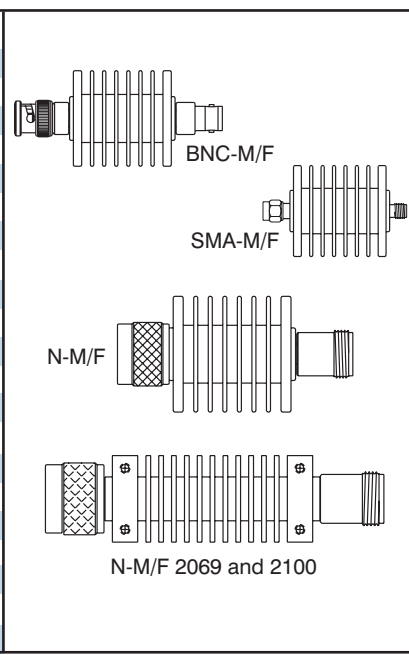
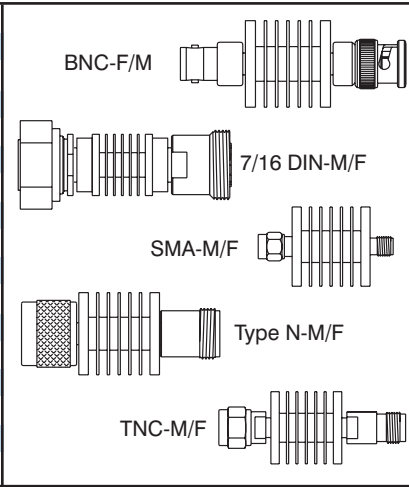

MODEL NO.	FREQ. (GHz)	CONNECTOR	VSWR	ATTN (dB)
<b>50 Watt Attenuators, Convection Cooled</b>				
2B50W	2.5	SMA-M/F, M/M, F/F	1.25:1	0,3,6,10,20,30,40
6B50W	6	SMA-M/F, M/M, F/F	1.25:1	0,3,6,10,20,30,40
12B50W	12.4	SMA-M/F, M/M, F/F	1.35:1	0,3,6,10,20,30,40
18B50W	18	SMA-M/F, M/M, F/F	1.45:1	0,3,6,10,20,30,40
2N50W	2.5	N-M/F, M/M, F/F	1.25:1	0,3,6,10,20,30,40
6N50W	6	N-M/F, M/M, F/F	1.25:1	0,3,6,10,20,30,40
12N50W	12.4	N-M/F, M/M, F/F	1.35:1	0,3,6,10,20,30,40
18N50W	18	N-M/F, M/M, F/F	1.45:1	0,3,6,10,20,30,40
2BNC50W	2.5	BNC- M/F, M/M, F/F	1.25:1	0,3,6,10,20,30,40
4BNC50W	4	BNC- M/F, M/M, F/F	1.25:1	0,3,6,10,20,30,40
2T50W	2.5	TNC-M/F, M/M, F/F	1.25:1	0,3,6,10,20,30,40
6T50W	6	TNC-M/F, M/M, F/F	1.25:1	0,3,6,10,20,30,40
12T50W	12.4	TNC-M/F, M/M, F/F	1.35:1	0,3,6,10,20,30,40
18T50W	18	TNC-M/F, M/M, F/F	1.45:1	0,3,6,10,20,30,40
2D50W	2.5	7/16 DIN-M/F, M/M, F/F	1.25:1	0,3,6,10,20,30,40
4D50W	4	7/16 DIN-M/F, M/M, F/F	1.25:1	0,3,6,10,20,30,40
7D50W	7.5	7/16 DIN-M/F, M/M, F/F	1.45:1	0,3,6,10,20,30,40

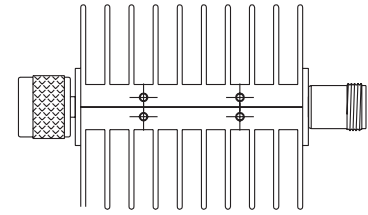

N-M/F

<b>50 Watt Attenuators, Conduction Cooled</b>				
2042	4	N-M/F, M/M, F/F	1.25:1	3,6,10,20,30,40
2042S	4	SMA-M/F, M/M, F/F	1.25:1	3,6,10,20,30,40
9037	18	SMA-M/F, M/M, F/F	1.45:1	3,6,10,20,30,40
2042T	4	TNC-M/F, M/M, F/F	1.25:1	3,6,10,20,30,40



N-M/F 2042

<b>100 Watt Attenuators, Convection Cooled</b>				
1B100W	1.5	SMA-M/F, M/M, F/F	1.20:1	3,6,10,20,30,40
2B100W	2.5	SMA-M/F, M/M, F/F	1.30:1	3,6,10,20,30,40
6B100W	6	SMA-M/F, M/M, F/F	1.40:1	3,6,10,20,30,40
1N100W	1.5	N-M/F, M/M, F/F	1.20:1	3,6,10,20,30,40
2N100W	2.5	N-M/F, M/M, F/F	1.35:1	3,6,10,20,30,40
6N100W	6	N-M/F, M/M, F/F	1.40:1	3,6,10,20,30,40
1BNC100W	1.5	BNC-M/F, M/M, F/F	1.25:1	3,6,10,20,30,40
2BNC100W	2.5	BNC-M/F, M/M, F/F	1.35:1	3,6,10,20,30,40
4BNC100W	4	BNC-M/F, M/M, F/F	1.45:1	3,6,10,20,30,40
1T100W	1.5	TNC-M/F, M/M, F/F	1.20:1	3,6,10,20,30,40
2T100W	2.5	TNC-M/F, M/M, F/F	1.30:1	3,6,10,20,30,40
6T100W	6	TNC-M/F, M/M, F/F	1.40:1	3,6,10,20,30,40
1D100W	1.5	7/16 DIN-M/F, M/M, F/F	1.25:1	3,6,10,20,30,40
2D100W	2.5	7/16 DIN-M/F, M/M, F/F	1.35:1	3,6,10,20,30,40
6D100W	6	7/16 DIN-M/F, M/M, F/F	1.45:1	3,6,10,20,30,40

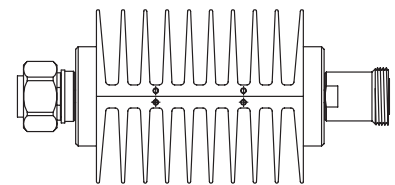

7/16 DIN-M/F

<b>200 Watt Attenuators, Convection Cooled</b>				
1B200W	1.5	SMA-M/F, M/M, F/F	1.20:1	3,6,10,20,30,40
2B200W	2.5	SMA-M/F, M/M, F/F	1.30:1	3,6,10,20,30,40
1N200W	1.5	N-M/F, M/M, F/F	1.15:1	3,6,10,20,30,40
2N200W	2.5	N-M/F, M/M, F/F	1.25:1	3,6,10,20,30,40
1T200W	1.5	TNC-M/F, M/M, F/F	1.15:1	3,6,10,20,30,40
2T200W	2.5	TNC-M/F, M/M, F/F	1.25:1	3,6,10,20,30,40
1D200W	1.5	7/16 DIN-M/F, M/M, F/F	1.15:1	3,6,10,20,30,40
2D200W	2.5	7/16 DIN-M/F, M/M, F/F	1.25:1	3,6,10,20,30,40

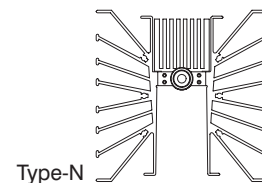

Type-N

<b>300 Watt Attenuators, Convection Cooled</b>				
1B300W	1.5	SMA-M/F, M/M, F/F	1.20:1	3,6,10,20,30,40
2B300W	2.5	SMA-M/F, M/M, F/F	1.20:1	3,6,10,20,30,40
1N300W	1.5	N-M/F, M/M, F/F	1.20:1	3,6,10,20,30,40
2N300W	2.5	N-M/F, M/M, F/F	1.30:1	3,6,10,20,30,40
1T300W	1.5	TNC-M/F, M/M, F/F	1.20:1	3,6,10,20,30,40
2T300W	2.5	TNC-M/F, M/M, F/F	1.30:1	3,6,10,20,30,40
1D300W	1.5	7/16 DIN-M/F, M/M, F/F	1.20:1	3,6,10,20,30,40
2D300W	2.5	7/16 DIN-M/F, M/M, F/F	1.30:1	3,6,10,20,30,40

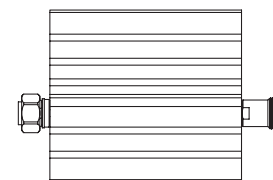

7/16 DIN-M/F

# Termination Reference Guide

## Terminations—Power Handling vs. Frequency vs. Connector Type

GHz ▶	DC-1	DC-2	DC-3	DC-4	DC-6	DC-7.5	DC-12.4	DC-18	DC-23	DC-26.5	DC-40	DC-50
<b>F</b>	2W	2W	2 W									
<b>7/16</b>	300W	300W	300W	100W	100W	50W						
<b>BNC</b>	300W	300W	300W	50W								
<b>N</b>	300W	300W	300W	100W	100W	50W	50W	50W				
<b>TNC</b>	300W	300W	300W	100W	100W	50W	50W	50W				
<b>SMA</b>	300W	300W	300W	100W	100W	50W	50W	50W	2W	1W		
<b>SMB</b>	1W	1W	1W	1W	1W							
<b>2.9mm</b>	2W	2W	2W	2W	2W	2W	2W	2W	2W	2W	.5W	
<b>GPO<sup>TM</sup>/SMP</b>	1W	1W	1W	1W	1W	1W	1W	1W	1W	1W		
<b>SMPM</b>	.5W	.5W	.5W	.5W	.5W	.5W	.5W	.5W	.5W	.5W	.5W	.5W
<b>2.4mm</b>	.5W	.5W	.5W	.5W	.5W	.5W	.5W	.5W	.5W	.5W	.5W	.5W

MODEL NO.    FREQ. (GHz)    CONNECTOR    VSWR

### 1 and 2 Watt Ultra Low Cost Terminations

TS398M	(1W)	2.5	SMA-M	1.15:1
3201-NM		1	N-M	1.05:1
3202-NM		2.5	N-M	1.10:1
3204-NM		4	N-M	1.10:1
3201-BNCM		1	BNC-M	1.10:1
3202-BNCM		2.5	BNC-M	1.20:1
3204-BNCM		4	BNC-M	1.35:1
3201-TNCM		1	TNC-M	1.05:1
3202-TNCM		2.5	TNC-M	1.15:1
3204-TNCM		4	TNC-M	1.15:1
3201-SMBP		1	SMBP (Pin)	1.10:1
3202-SMBP		2	SMBP (Pin)	1.15:1
3204-SMBP		4	SMBP (Pin)	1.20:1
3206-SMBP		6	SMBP (Pin)	1.25:1
3201-SMBS		1	SMBS (Socket)	1.10:1
3202-SMBS		2	SMBS (Socket)	1.15:1
3204-SMBS		4	SMBS (Socket)	1.20:1
3206-SMBS		6	SMBS (Socket)	1.25:1

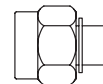

TS398

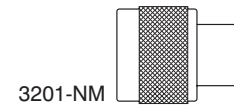

3201-NM

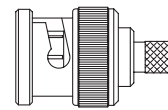

3201-BNCM

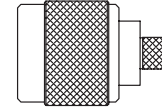

3201-TNCM

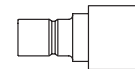

3201-SMBP



3201-SMBS

### .5Watt and 1 Watt Terminations

3016A-137*		3	SMA-M	1.20:1
3016A-067*		6	SMA-M	1.10:1
TS060*		6	SMA-M, SMA-F	1.10:1
TS120*		12.4	SMA-M, SMA-F	1.15:1
3016A*		18	SMA-M	1.30:1
TS180*		18	SMA-M, SMA-F	1.20:1
TS260*		26.5	SMA-M, SMA-F	1.25:1
TP180	(1.0W)	18	SMP-M, SMP-F	1.20:1
TP260	(1.0W)	26.5	SMP-M, SMP-F	1.30:1
TG180	(1.0W)	18	GPO-M, GPO-F	1.21:1
TG260	(1.0W)	26.5	GPO-M, GPO-F	1.30:1
TS400*	(0.5W)	40	2.9mm-M, 2.9mm-F	1.20:1
TS400H*	(0.5W)	40	2.9mm-M, 2.9mm-F	1.20:1
TE400*	(0.5W)	40	2.4mm-M, 2.4mm-F	1.40:1
TE500*	(0.5W)	50	2.4mm-M, 2.4mm-F	1.60:1

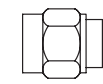

SMA-M

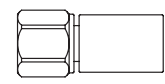

2.4mm-M

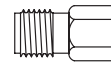

SMA-F

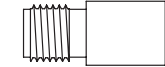

2.9mm-F

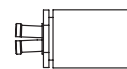

GPO™-F

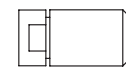

SMP-M



SMP-F

\*With chain, add suffix "C"

Note: G and P models are full detent, GL and PL models are limited detent

MODEL NO.	FREQ. (GHz)	CONNECTOR	VSWR
<b>2 Watt Terminations</b>			
3029*	4	BNC-F	1.15:1
3038*	4	BNC-M	1.20:1
3030*	4	BNC-M	1.15:1
3004-067*	6	SMA-M, SMA-F	1.10:1
3004*	18	SMA-M, SMA-F	1.20:1
3070-067*	6	N-M, N-F	Brass 1.10:1
TN060*	6	N-M, N-F	1.15:1
TN120*	12.4	N-M, N-F	1.20:1
TN180*	18	N-M, N-F	1.25:1
3018, 3033*	18	N-M, N-F	Brass 1.30:1
3070*	18	N-M, N-F	Brass 1.20:1
3101*, 3102*	18	N-M, N-F	1.06:1
TT060*	6	TNC-M, TNC-F	1.15:1
TT120*	12.4	TNC-M, TNC-F	1.20:1
3069*	12.4	TNC-M, TNC-F	Brass 1.15:1
TT180*	18	TNC-M, TNC-F	1.25:1 <sup>H=with Hex</sup>

\*With chain, add suffix "C"

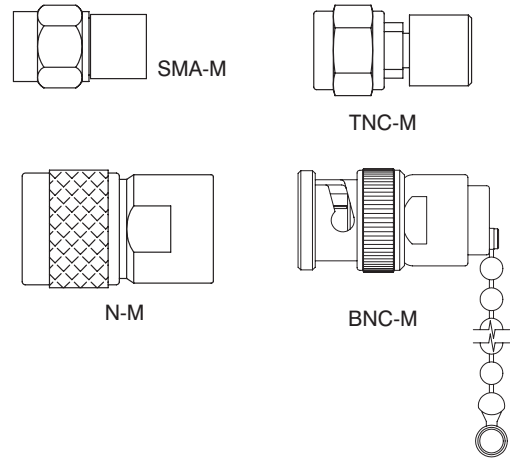

### 75 Ohm 1 and 2 Watt Terminations

3038/75 (1W)	1	BNC-M	1.10:1
3201-BNCM/75	1	BNC-M	1.15:1
TF030M	3	F-M	1.20:1
TF030F	3	F-F	1.20:1
TN040/75	4	N-M, N-F	1.25:1

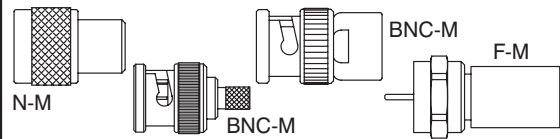

### 1 Watt DC Blocking Terminations (Also See DC Block Section, page 19)

8530S	30 kHz-18	SMA	INNER
8530N	30 kHz-23	N	INNER
8530P	30 kHz-23	SMP	INNER

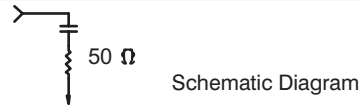

### 2 Watt Terminations, Feedthru

3032	0.5	BNC-M/F	1.25:1
3088	0.5	N-M/F	1.65:1
3008, 3008H	1	SMA-M/F	1.25:1
3009, 3009H	1	SMA-M/M	1.25:1
3010, 3010H	1	SMA-F/F	1.25:1

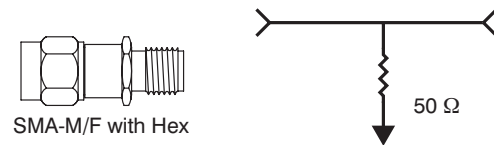

### 5 Watt Terminations

TB020-5W	2.5	BNC-M, BNC-F	1.25:1
3132	2.5	BNC-M, BNC-F	1.25:1
TB040-5W	4	BNC-M, BNC-F	1.25:1
3073B	4	BNC-F, BNC-M	1.25:1
3134	4	BNC-M, BNC-F	1.25:1
TD020-5W	2.5	7/16 DIN-M, 7/16 DIN-F	1.25:1
TD040-5W	4	7/16 DIN-M, 7/16 DIN-F	1.25:1
TD075-5W	7.5	7/16 DIN-M, 7/16 DIN-F	1.45:1
3073D	7.5	7/16 DIN-M, 7/16 DIN-F	1.45:1
TS060-5W	6	SMA-M, SMA-F	1.15:1
3073XX	12.4	SMA, N, TNC	1.20:1
TS120-5W	12.4	SMA-M, SMA-F	1.20:1
TS180-5W	18	SMA-M, SMA-F	1.25:1
TN060-5W	6	N-M, N-F	1.25:1
TN120-5W	12.4	N-M, N-F	1.20:1
TN180-5W	18	N-M, N-F	1.25:1
3018-5W	18	N-M	Brass 1.30:1
3033-5W	18	N-F	Brass 1.30:1
TT060-5W	6	TNC-M, TNC-F	1.15:1
TT120-5W	12.4	TNC-M, TNC-F	1.20:1
TT180-5W	18	TNC-M, TNC-F	1.25:1

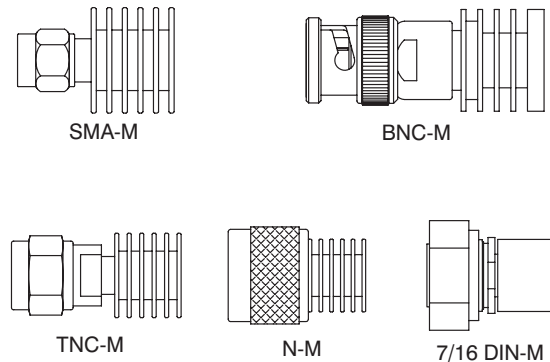

# Termination Reference Guide

MODEL NO.	FREQ. (GHz)	CONNECTOR	VSWR
-----------	-------------	-----------	------

## 10 Watt Termination, Conduction Cooled

3706F	2.5	SMA-F	1.15:1
-------	-----	-------	--------

## 10 Watt Terminations, Convection Cooled

TB020-10W	2.5	BNC-M, BNC-F	1.25:1
3142	2.5	BNC-M, BNC-F	1.25:1
TB040-10W	4	BNC-M, BNC-F	1.25:1
3144	4	BNC-M, BNC-F	1.25:1
TD020-10W	2.5	7/16 DIN-M, 7/16 DIN-F	1.20:1
TD040-10W	4	7/16 DIN-M, 7/16 DIN-F	1.20:1
TD075-10W	7.5	7/16 DIN-M, 7/16 DIN-F	1.30:1
TS060-10W	6	SMA-M, SMA-F	1.20:1
TS120-10W	12.4	SMA-M, SMA-F	1.30:1
TS180-10W	18	SMA-M, SMA-F	1.40:1
3050	18	SMA-M, SMA-F	1.35:1
3093	12.4	N-M, N-F	1.25:1
TN060-10W	6	N-M, N-F	1.25:1
TN120-10W	12.4	N-M, N-F	1.30:1
TN180-10W	18	N-M, N-F	1.35:1
TT060-10W	6	TNC-M, TNC-F	1.20:1
TT120-10W	12.4	TNC-M, TNC-F	1.30:1
TT180-10W	18	TNC-M, TNC-F	1.40:1

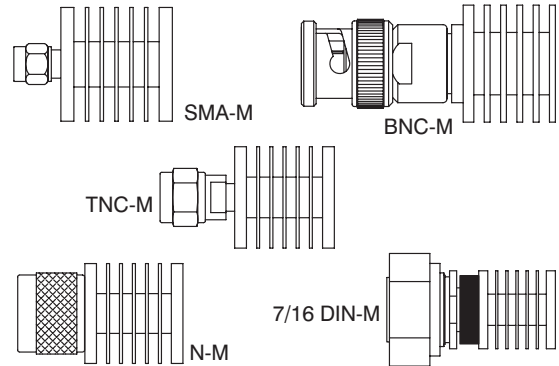

## 20 Watt Terminations, Convection Cooled

TS020-20W	2.5	SMA-M, SMA-F	1.20:1
TS060-20W	6	SMA-M, SMA-F	1.20:1
TS120-20W	12.4	SMA-M, SMA-F	1.30:1
TS180-20W	18	SMA-M, SMA-F	1.40:1
TN020-20W	2.5	N-M, N-F	1.20:1
TN060-20W	6	N-M, N-F	1.20:1
TN120-20W	12.4	N-M, N-F	1.30:1
TN180-20W	18	N-M, N-F	1.40:1
3047M	18	N-M	1.20:1
TB020-20W	2.5	BNC-M, BNC-F	1.25:1
TB040-20W	4	BNC-M, BNC-F	1.25:1
TT020-20W	2.5	TNC-M, TNC-F	1.20:1
TT060-20W	6	TNC-M, TNC-F	1.20:1
TT120-20W	12.4	TNC-M, TNC-F	1.30:1
TT180-20W	18	TNC-M, TNC-F	1.40:1
TD020-20W	2.5	7/16 DIN-M, 7/16 DIN-F	1.25:1
TD040-20W	4	7/16 DIN-M, 7/16 DIN-F	1.25:1
TD080-20W	7.5	7/16 DIN-M, 7/16 DIN-F	1.45:1

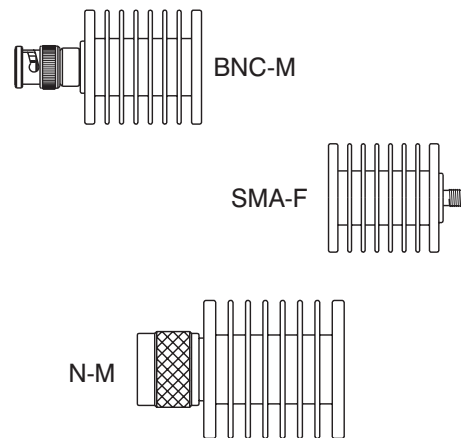

## 25 Watt Terminations, Convection Cooled

TD020-25W	2.5	7/16 DIN-M, 7/16 DIN-F	1.20:1
TD040-25W	4	7/16 DIN-M, 7/16 DIN-F	1.20:1
TD075-25W	7.5	7/16 DIN-M, 7/16 DIN-F	1.30:1
3112-XX	18	7/16 DIN, SMA, TNC, N	1.50:1
TS060-25W	6	SMA-M, SMA-F	1.20:1
TS120-25W	12.4	SMA-M, SMA-F	1.30:1
TS180-25W	18	SMA-M, SMA-F	1.40:1
TN060-25W	6	N-M, N-F	1.20:1
TN120-25W	12.4	N-M, N-F	1.30:1
TN180-25W	18	N-M, N-F	1.40:1
TT060-25W	6	TNC-M, TNC-F	1.20:1
TT120-25W	12.4	TNC-M, TNC-F	1.30:1
TT180-25W	18	TNC-M, TNC-F	1.40:1

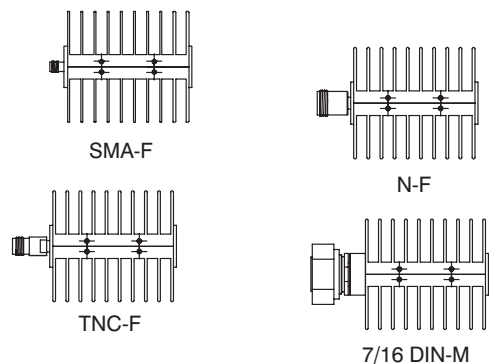

## 40 Watt Termination, Convection Cooled

3114S	12.4	SMA-M, SMA-F	1.35:1
-------	------	--------------	--------



MODEL NO.	FREQ. (GHz)	CONNECTOR	VSWR
-----------	-------------	-----------	------

### 50 Watt Termination, Conduction Cooled

3060	18	SMA-M, SMA-F	1.45:1
------	----	--------------	--------

### 50 Watt Terminations, Convection Cooled

TS060-50W	6	SMA-M, SMA-F	1.25:1
TS120-50W	12.4	SMA-M, SMA-F	1.35:1
TS180-50W	18	SMA-M, SMA-F	1.45:1
TN060-50W	6	N-M, N-F	1.25:1
TN120-50W	12.4	N-M, N-F	1.35:1
3114N	12.4	N-M, N-F	1.35:1
TN180-50W	18	N-M, N-F	1.45:1
TB020-50W	2.5	BNC-M, BNC-F	1.25:1
TB040-50W	4	BNC-M, BNC-F	1.25:1
3114B	4	BNC-M, BNC-F	1.25:1
TD020-50W	2.5	7/16 DIN-M, 7/16 DIN-F	1.25:1
TD040-50W	4	7/16 DIN-M, 7/16 DIN-F	1.25:1
TD075-50W	7.5	7/16 DIN-M, 7/16 DIN-F	1.45:1
3114D	7.5	7/16 DIN-M, 7/16-DIN-F	1.25:1
TT060-50W	6	TNC-M, TNC-F	1.25:1
TT120-50W	12.4	TNC-M, TNC-F	1.35:1
TT180-50W	18	TNC-M, TNC-F	1.45:1
3114T	12.4	TNC-M, TNC-F	1.35:1

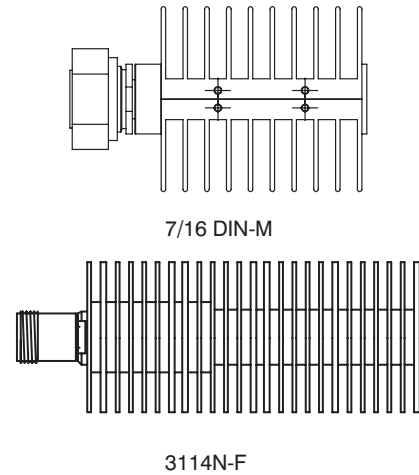

### 100 Watt Terminations, Convection Cooled

TS010-100W	1.5	SMA-M, SMA-F	1.20:1
TS020-100W	2.5	SMA-M, SMA-F	1.30:1
TS060-100W	6	SMA-M, SMA-F	1.40:1
TN010-100W	1.5	N-M, N-F	1.20:1
TN020-100W	2.5	N-M, N-F	1.30:1
TN060-100W	6	N-M, N-F	1.40:1
TB010-100W	1.5	BNC-M, BNC-F	1.25:1
TB020-100W	2.5	BNC-M, BNC-F	1.35:1
TB040-100W	4	BNC-M, BNC-F	1.45:1
TT010-100W	1.5	TNC-M, TNC-F	1.20:1
TT020-100W	2.5	TNC-M, TNC-F	1.30:1
TT060-100W	6	TNC-M, TNC-F	1.40:1
TD010-100W	1.5	7/16 DIN-M, 7/16 DIN-F	1.25:1
TD020-100W	2.5	7/16 DIN-M, 7/16 DIN-F	1.35:1
TD060-100W	6	7/16 DIN-M, 7/16 DIN-F	1.45:1

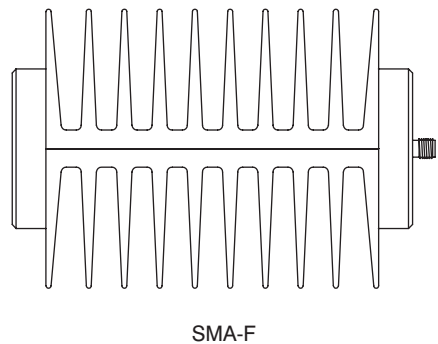

### 300 Watt Terminations, Convection Cooled

TS010-300W	1.5	SMA-M, SMA-F	1.20:1
TS020-300W	2.5	SMA-M, SMA-F	1.30:1
TS030-300W	3	SMA-M, SMA-F	1.30:1
TN010-300W	1.5	N-M, N-F	1.20:1
TN020-300W	2.5	N-M, N-F	1.30:1
TN030-300W	3	N-M, N-F	1.30:1
TB010-300W	1.5	BNC-M, BNC-F	1.25:1
TB020-300W	2.5	BNC-M, BNC-F	1.35:1
TB030-300W	3	BNC-M, BNC-F	1.45:1
TT010-300W	1.5	TNC-M, TNC-F	1.15:1
TT020-300W	2.5	TNC-M, TNC-F	1.25:1
TT030-300W	4	TNC-M, TNC-F	1.35:1
TD010-300W	1.5	7/16 DIN-M, 7/16 DIN-F	1.25:1
TD020-300W	2.5	7/16 DIN-M, 7/16 DIN-F	1.35:1
TD030-300W	3	7/16 DIN-M, 7/16 DIN-F	1.35:1

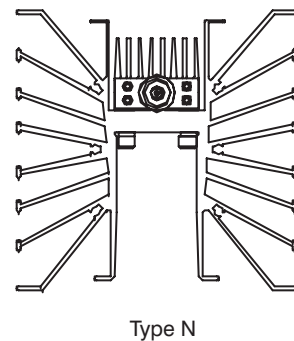

## Adapters

Connector	F	7/16	BNC	N	TNC	7mm	SMA	3.5mm	2.9mm	GPO <sup>TM</sup> /SMP	2.4mm	1.85mm
F	①		①②	①②	②		②					
7/16				③								
BNC	①②											
N	①②	③					③					
TNC	②											
7mm												
SMA	②			③			③					
3.5mm												
2.9mm												
GPO <sup>TM</sup> /SMP												
2.4mm												
1.85mm												

① Adapter, 75  $\Omega$  both sides (page 16)

② Impedance Matching Pad where F connector only is 75  $\Omega$  (page 5)  
Also available with Quick Connect Option

Note: Highlighted squares denote available connector configurations

CONNECTORS	MODEL NO.	FREQ. (Ghz)	VSWR	DESCRIPTION
<b>SMA In Series Adapters</b>				
F/F with O-Ring Seal	5211-137	3	1.10:1	Bulkhead Feedthru
F/F M/M M/F	5010, 5020, 5030	18	1.20:1	
F/F M/M M/F	5043, 5044, 5045	18	1.20:1	Gold Plated
M/F	5030Q	18	1.25:1	Quick Connect
M/F M/M F/F	5311, 5312, 5313	18	1.25:1	Flange Mount, 0.5" Sq
M/F M/M F/F	5311A, 5312A, 5313A	18	1.20:1	Flange Mount, 0.5" Sq.
F/F with O-Ring Seal	5211	18	1.15:1	Bulkhead Feedthru
F/F (Au is Gold Plated)	5205, 5205/Au	18	1.15:1	Bulkhead Feedthru
F/F M/M M/F	5163, 5164, 5165	26.5	1.20:1	
F/F with O-Ring Seal	5218	26.5	1.30:1	Bulkhead Feedthru
<b>SMA Between Series Adapters</b>				
SMA-M N-M	5061	6	1.30:1	Ultra Low Cost Brass
SMA-M N-F	5062	6	1.30:1	Ultra Low Cost Brass
SMA-F N-M	5063	6	1.30:1	Ultra Low Cost Brass
SMA-F N-F	5064	6	1.30:1	Ultra Low Cost Brass
SMA-M N-M	5306-067	6	1.07:1	Flange Mount 1" Sq.
SMA-M N-F	5307-067	6	1.07:1	Flange Mount 1" Sq.
SMA-F N-M	5308-067	6	1.07:1	Flange Mount 1" Sq.
SMA-F N-F	5309-067	6	1.07:1	Flange Mount 1" Sq.
SMA-F 7/16-F	5714	7.5	1.35:1	
SMA-M 7/16-F	5715	7.5	1.35:1	
SMA-F 7/16-M	5716	7.5	1.35:1	
SMA-M 7/16-M	5717	7.5	1.35:1	
SMA-M N-M	5056	18	1.25:1	Short Profile
SMA-M N-F	5057	18	1.25:1	Short Profile
SMA-F N-F	5058	18	1.25:1	Short Profile
SMA-F N-M	5059	18	1.25:1	Short Profile
SMA-M N-M	5106	18	1.12:1	Precision
SMA-M N-F	5107	18	1.12:1	Precision
SMA-F N-M	5108	18	1.12:1	Precision
SMA-F N-F	5109	18	1.12:1	Precision
SMA-M N-F	5057Q	18	1.30:1	Quick Connect
SMA-M N-M	5306	18	1.12:1	Flange Mount 1" Sq.
SMA-M N-F	5307	18	1.12:1	Flange Mount 1" Sq.
SMA-F N-M	5308	18	1.12:1	Flange Mount 1" Sq.
SMA-F N-F	5309	18	1.12:1	Flange Mount 1" Sq.
SMA-F N-F	5209	18	1.20:1	Bulkhead Feedthru
SMA-M N-F	5210	18	1.20:1	Bulkhead Feedthru
SMA-F N-F w/ O-Ring Seal	5212	18	1.20:1	Bulkhead Feedthru
SMA-M N-F w/ O-Ring Seal	5213	18	1.20:1	Bulkhead Feedthru
SMA-M BNC-M	5011	8	1.25:1	
SMA-M BNC-F	5012	8	1.25:1	
SMA-F BNC-M	5013	8	1.25:1	
SMA-F BNC-F	5014	8	1.25:1	
SMA-M TNC-M	5015	18	1.25:1	
SMA-M TNC-F	5016	18	1.25:1	
SMA-F TNC-M	5017	18	1.25:1	
SMA-F TNC-F	5018	18	1.25:1	
SMA-M GPO-M	5190G	18	1.20:1	Full Detent
SMA-M GPO-M	5190GL	18	1.20:1	Limited Detent
SMA-F GPO-M	5191G	18	1.20:1	Full Detent
SMA-F GPO-M	5191GL	18	1.20:1	Limited Detent
SMA-M GPO-F	5192G	18	1.20:1	
SMA-F GPO-F	5193G	18	1.20:1	
SMA-M SMP-M	5190P	18	1.20:1	Full Detent
SMA-M SMP-M	5190PL	18	1.20:1	Limited Detent
SMA-F SMP-M	5191P	18	1.20:1	Full Detent
SMA-F SMP-M	5191PL	18	1.20:1	Limited Detent

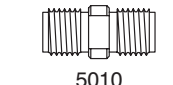

5010

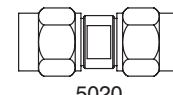

5020

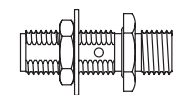

5218

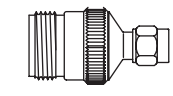

5062

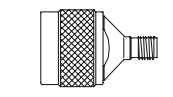

5059

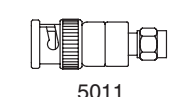

5011

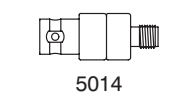

5014

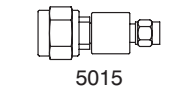

5015

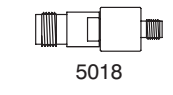

5018

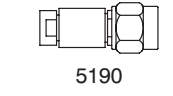

5190

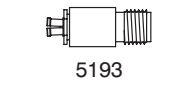



5193

# Adapter Reference Guide

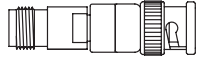
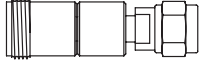
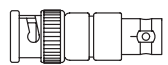
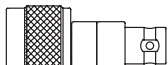
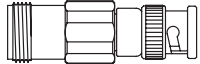
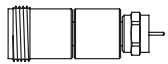
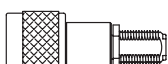
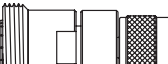

CONNECTORS			MODEL NO.	FREQ.	VSWR	DESCRIPTION	
<b>SMA Between Series Adapters, Continued</b>							
SMA-M	SMP-F		5192P	18	1.20:1		
SMA-F	SMP-F		5193P	18	1.20:1		
SMA-M	3.5mm-M		5246	18	1.25:1		5247
SMA-M	3.5mm-F		5247	18	1.25:1		
SMA-F	3.5mm-M		5248	18	1.25:1		
SMA-F	3.5mm-F		5249	18	1.25:1		
SMA-F	1.85mm-M		5250	18	1.30:1		
SMA-M	1.85mm-M		5251	18	1.30:1		
SMA-M	1.85mm-F		5252	18	1.30:1		
SMA-F	1.85mm-F		5253	18	1.30:1		
<b>TYPE N In Series</b>							
F/F	M/M	M/F	5185, 5188, 5189	6	1.20:1	Ultra Low Cost, Brass	
F/F			5303-067	6	1.07:1	Flange Mount 1" sq.	
M/M			5304-067	6	1.07:1	Flange Mount 1" sq.	
M/F			5305-067	6	1.07:1	Flange Mount 1" sq.	
F/F	M/M	M/F	5003, 5004, 5005	18	1.25:1		
F/F	M/M	M/F	5103, 5104, 5105	18	1.12:1	Precision	
F/F			5208	18	1.15:1	Bulkhead Feedthru	
F/F with O-Ring Seal			5215	18	1.15:1	Bulkhead Feedthru	
F/F	M/M	M/F	5303, 5304, 5305	18	1.12:1	Flange Mount 1" sq.	
<b>TYPE N Between Series</b>							
N-M	TNC-M		5326-067	6	1.07:1	Flange Mount 1" sq.	
N-M	TNC-F		5327-067	6	1.07:1	Flange Mount 1" sq.	
N-F	TNC-M		5328-067	6	1.07:1	Flange Mount 1" sq.	
N-F	TNC-F		5329-067	6	1.07:1	Flange Mount 1" sq.	
N-M	TNC-M		5326	18	1.12:1	Flange Mount 1" sq.	
N-M	TNC-F		5327	18	1.12:1	Flange Mount 1" sq.	
N-F	TNC-M		5328	18	1.12:1	Flange Mount 1" sq.	
N-F	TNC-F		5329	18	1.12:1	Flange Mount 1" sq.	
N-M	BNC-M		5330	8	1.20:1	Flange Mount 1" sq.	
N-M	BNC-F		5331	8	1.20:1	Flange Mount 1" sq.	
N-F	BNC-M		5332	8	1.20:1	Flange Mount 1" sq.	
N-F	BNC-F		5333	8	1.20:1	Flange Mount 1" sq.	
N-F	2.4mm-M		5155	18	1.15:1		
N-F	2.4mm-F		5156	18	1.15:1		
N-M	2.4mm-M		5157	18	1.15:1		
N-M	2.4mm-F		5158	18	1.15:1		
N-M	2.9mm-M		5166	18	1.15:1	Precision	
N-F	2.9mm-F		5167	18	1.15:1	Precision	
N-M	2.9mm-F		5168	18	1.15:1	Precision	
N-F	2.9mm-M		5169	18	1.15:1	Precision	
N-M	3.5mm-M		5144	18	1.12:1		
N-M	3.5mm-F		5145	18	1.12:1		
N-F	3.5mm-M		5146	18	1.12:1		
N-F	3.5mm-F		5147	18	1.12:1		
N-M	1.85mm-M		5242	18	1.25:1		
N-F	1.85mm-M		5243	18	1.25:1		
N-M	1.85mm-F		5244	18	1.25:1		
N-F	1.85mm-F		5245	18	1.25:1		
N-M	SMA-F		5206	18	1.30:1	Bulkhead Feedthru	
N-F	SMA-F		5203	18	1.12:1	Bulkhead Feedthru	
N-F	SMA-M		5207	18	1.12:1	Bulkhead Feedthru	
N-F	SMA-M w/ O-Ring		5216	18	1.12:1	Bulkhead Feedthru	
N-F	SMA-F w/ O-Ring		5217	18	1.12:1	Bulkhead Feedthru	
<b>TNC In Series</b>							
F/F	M/M	M/F	5186, 5187, 5194	6	1.20:1	Ultra Low Cost, Brass	
M/F	F/F	M/M	5040, 5041, 5042	18	1.20:1		

CONNECTORS			MODEL NO.	FREQ. (Ghz)	VSWR	DESCRIPTION		
<b>TNC Between Series</b>								
TNC-M	BNC-M		5034	8	1.30:1			
TNC-F	BNC-M		5035	8	1.30:1			
TNC-M	BNC-F		5036	8	1.30:1			
TNC-F	BNC-F		5037	8	1.30:1			
TNC-M	N-F		5026	18	1.25:1			
TNC-F	N-F		5027	18	1.25:1			
TNC-M	N-M		5028	18	1.25:1			
TNC-F	N-M		5029	18	1.25:1			
TNC-M	N-M		5126	18	1.12:1	Precision		
TNC-F	N-M		5127	18	1.12:1	Precision		
TNC-M	N-F		5128	18	1.12:1	Precision		
TNC-F	N-F		5129	18	1.12:1	Precision		
<b>BNC In Series</b>								
M/F	F/F	M/M	5031, 5032, 5033	8	1.25:1			
<b>BNC Between Series</b>								
BNC-M	N-M		5021	8	1.30:1			
BNC-F	N-M		5022	8	1.30:1			
BNC-M	N-F		5023	8	1.30:1			
BNC-F	N-F		5024	8	1.30:1			
BNC-M	N-M		5130	8	1.15:1	Precision		
BNC-F	N-M		5131	8	1.15:1	Precision		
BNC-M	N-F		5132	8	1.15:1	Precision		
BNC-F	N-F		5133	8	1.15:1	Precision		
<b>TYPE F In Series</b>								
M/F	M/M	F/F	5230, 5231, 5232	3	1.30:1	75 Ω		
<b>TYPE F Between Series</b>								
F-M	N-M		5195	3	1.30:1	75 Ω Both Sides		
F-M	N-F		5196	3	1.30:1	75 Ω Both Sides		
F-F	N-M		5197	3	1.30:1	75 Ω Both Sides		
F-F	N-F		5198	3	1.30:1	75 Ω Both Sides		
F-M	BNC-M		5070	3	1.30:1	75 Ω Both Sides		
F-M	BNC-F		5071	3	1.30:1	75 Ω Both Sides		
F-F	BNC-M		5072	3	1.30:1	75 Ω Both Sides		
F-F	BNC-F		5073	3	1.30:1	75 Ω Both Sides		
<b>7/16 DIN In Series</b>								
F/F	M/M	M/F	5701, 5702, 5703	7.5	1.35:1			
<b>7/16 DIN Between Series</b>								
7/16 DIN-F	N-F		5704	7.5	1.35:1			
7/16 DIN-F	N-M		5705	7.5	1.35:1			
7/16 DIN-M	N-F		5706	7.5	1.35:1			
7/16 DIN-M	N-M		5707	7.5	1.35:1			
7/16 DIN-M	N-F		5706Q	7.5	1.35:1	Quick Connect		
7/16 DIN-M	N-M		5707Q	7.5	1.35:1	Quick Connect		
7/16 DIN-F	TNC-F		5708	7.5	1.35:1			
7/16 DIN-F	TNC-M		5709	7.5	1.35:1			
7/16 DIN-M	TNC-F		5710	7.5	1.35:1			
7/16 DIN-M	TNC-M		5711	7.5	1.35:1			
<b>1.85mm In Series</b>								
F/F	M/M	M/F	5173, 5174, 5175	65	1.40:1			
F/F with O-Ring Seal			5289	65	1.40:1	Bulkhead Feedthru		
F/F without O-Ring Seal			5290	65	1.40:1	Bulkhead Feedthru		
<b>2.4mm In Series</b>								
F/F	M/M	M/F	5148, 5149, 5150	50	1.30:1			
F/F with O-Ring Seal			5221	50	1.35:1	Bulkhead Feedthru		
<b>2.4mm Between Series</b>								
2.4mm-M	SMA-M		5080	26.5	1.20:1			
2.4mm-F	SMA-M		5081	26.5	1.20:1			



# Adapter Reference Guide

CONNECTORS	MODEL NO.	FREQ. (Ghz)	VSWR	DESCRIPTION
<b>2.4mm Between Series, Continued</b>				
2.4mm-M 3.5mm-M	5065	34	1.25:1	
2.4mm-M 3.5mm-F	5066	34	1.25:1	
2.4mm-F 3.5mm-M	5067	34	1.25:1	
2.4mm-F 3.5mm-F	5068	34	1.25:1	
2.4mm-F 2.9mm-F	5151	40	1.30:1	
2.4mm-F 2.9mm-M	5152	40	1.30:1	
2.4mm-M 2.9mm-F	5153	40	1.30:1	
2.4mm-M 2.9mm-M	5154	40	1.30:1	
2.4mm-M 1.85mm-M	5075	50	1.35:1	
2.4mm-M 1.85mm-F	5076	50	1.35:1	
2.4mm-F 1.85mm-M	5077	50	1.35:1	
2.4mm-F 1.85mm-F	5078	50	1.35:1	
<b>2.9mm In Series</b>				
F/F M/M M/F	5160, 5161, 5162	26.5	1.15:1	
F/F	5338	26.5	1.25:1	Flange Mount, 0.5" sq.
F/F M/M M/F	5170, 5171, 5172	40	1.30:1	
F/F with O-Ring Seal	5214	40	1.30:1	Bulkhead Feedthru
F/F	5344	40	1.35:1	Flange Mount, 0.5" sq.
<b>2.9mm Between Series</b>				
2.9mm-M SMA-M	5262	26.5	1.25:1	
2.9mm-M SMA-F	5263	26.5	1.25:1	
2.9mm-F SMA-M	5264	26.5	1.25:1	
2.9mm-F SMA-F	5265	26.5	1.25:1	
2.9mm-F 3.5mm-F	5266	34	1.25:1	
2.9mm-F 3.5mm-M	5267	34	1.25:1	
2.9mm-M 3.5mm-F	5268	34	1.25:1	
2.9mm-M 3.5mm-M	5269	34	1.25:1	
2.9mm-M 1.85mm-M	5258	40	1.40:1	
2.9mm-M 1.85mm-F	5259	40	1.40:1	
2.9mm-F 1.85mm-M	5260	40	1.40:1	
2.9mm-F 1.85mm-F	5261	40	1.40:1	
2.9mm-F 2.4mm-F w/ O-Ring	5237	40	1.35:1	Bulkhead Feedthru
<b>3.5mm In Series</b>				
M/F M/M F/F	5084, 5085, 5086	34	1.25:1	
<b>3.5mm Between Series</b>				
3.5mm-F 1.85mm-M	5254	34	1.30:1	
3.5mm-M 1.85mm-F	5255	34	1.30:1	
3.5mm-F 1.85mm-F	5256	34	1.30:1	
3.5mm-M 1.85mm-M	5257	34	1.30:1	
<b>7mm Between Series</b>				
7mm 7/16 DIN-M	5712	7.5	1.35:1	
7mm 7/16 DIN-F	5713	7.5	1.35:1	
7mm BNC-M	5116	8	1.15:1	
7mm BNC-F	5117	8	1.15:1	
7mm SMA-M	5110	18	1.12:1	
7mm SMA-F	5111	18	1.12:1	
7mm N-M	5112	18	1.12:1	
7mm N-F	5113	18	1.12:1	
7mm TNC-M	5114	18	1.12:1	
7mm TNC-F	5115	18	1.12:1	
7mm 3.5mm-M	5140	18	1.08:1	
7mm 3.5mm-F	5141	18	1.08:1	
7mm 2.4mm-M	5181	18	1.10:1	
7mm 2.4mm-F	5182	18	1.10:1	
7mm 2.9mm-M	5183	18	1.10:1	
7mm 2.9mm-F	5184	18	1.10:1	
7mm SMA-M	5314	18	1.12:1	Flange Mount 1" sq.
7mm SMA-F	5315	18	1.12:1	Flange Mount 1" sq.

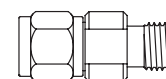

5153

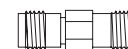

5078



5162

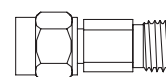

5255

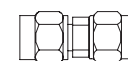

5257

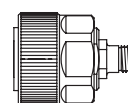

5111

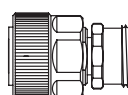

5113

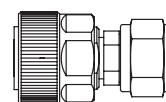

5114

Inmet inner DC blocks have a capacitor in-series with the center conductor which prevents the flow of audio and direct current (DC) frequencies while offering minimum interference to RF signals up to 50GHz. Similarly outer DC blocks have a capacitor in-series with the outer conductor and the inner/outer types have capacitors in-series with both inner and outer conductors.

Insulation material on the outer DC blocks is a PEEK shell. Applications include ground loop elimination, signal source modulation leakage suppression, system signal-to-noise ratio improvement, test setup isolation and other situations where undesired DC or audio current flows in the system.

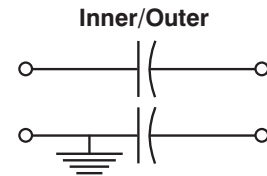
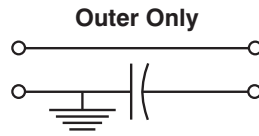
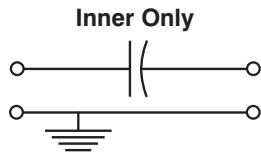

MODEL NO.	FREQ. (GHz)	CONNECTOR	VOLTAGE	BLOCK TYPE
<b>DC Blocks, SMA</b>				
8037	0.01-18	SMA-M/F	200	INNER
8038	0.01-18	SMA-M/F	200	OUTER
8039	0.01-18	SMA-M/F	200	INNER-OUTER



<b>DC Blocks, SMA Microminiature</b>				
8055	0.01-18	SMA-M/F	200	INNER
8055H	0.01-18	SMA-M/F	200	INNER



<b>DC Blocks</b>				
8046	0.01-18	N-M/F	200	INNER
8047	0.01-18	N-M/F	200	OUTER
8048	0.01-18	N-M/F	200	INNER/OUTER
8080	0.01-4	BNC-M/F	200	INNER
8081	0.01-4	BNC-M/F	200	OUTER
8082	0.01-4	BNC-M/F	200	INNER/OUTER
8070	0.01-18	TNC-M/F	200	INNER
8071	0.01-18	TNC-M/F	200	OUTER
8072	0.01-18	TNC-M/F	200	INNER/OUTER
8060A	0.007-26.5	2.9mm-M/F	50	INNER
8063A	0.007-26.5	2.9mm-F/F	50	INNER
8066A	0.007-26.5	2.9mm-M/M	50	INNER
8061	0.01-26.5	2.9mm-M/F	200	OUTER
8062A	0.01-26.5	2.9mm-M/F	200	INNER/OUTER
8141A	0.01-40	2.9mm-M/F	200	INNER
8142	0.01-40	2.9mm-M/F	200	OUTER
8143A	0.01-40	2.9mm-M/F	200	INNER/OUTER
8144A	0.01-40	2.9mm-F/F	200	INNER
8145	0.01-40	2.9mm-F/F	200	OUTER
8146A	0.01-40	2.9mm-F/F	200	INNER/OUTER
8177	0.01-50	2.4mm-M/F	75	INNER
8178	0.01-50	2.4mm-M/F	75	OUTER
8179	0.01-50	2.4mm-M/F	75	INNER/OUTER
8100	0.30-2.5	7/16-M/F	100	INNER

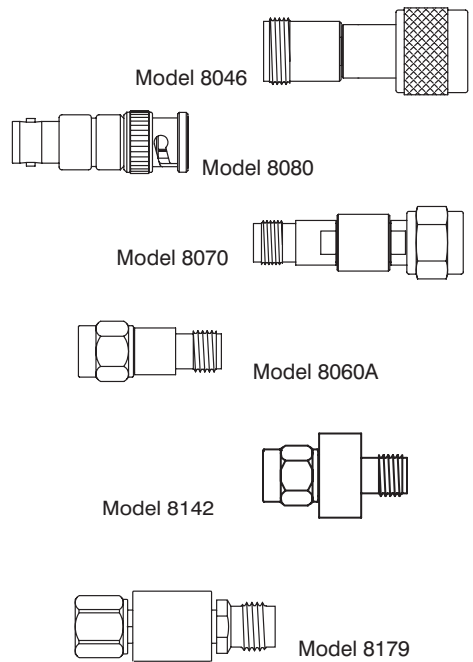

<b>DC Blocks, High Voltage</b>				
8529A, AH	0.1-4	SMA-M/F	900	INNER
8532-SI-HV	0.1-18	SMA-M/F	950	INNER
8532-NI-HV	0.1-18	N-M/F	950	INNER
8532-TI-HV	0.1-18	TNC-M/F	950	INNER
8550	0.8-2.8	7/16-M/F	3000	INNER



# DC Block Reference Guide

MODEL NO.    FREQ. (GHz)    CONNECTOR    VOLTAGE    BLOCK TYPE

## DC Blocks, Broadband

8535	7 kHz-23	SMA-M/F	100	INNER
8535G, 8535GL	7 kHz-26.5	GPO-M/F	50	INNER
8535P, 8535PL	7 kHz-26.5	SMP-M/F	50	INNER
8535K, 8535KH	7 kHz-40	2.9mm-M/F	35	INNER
8535E	7 kHz-50	2.4mm-M/F	35	INNER

Note: GPO™ and SMP male connectors are available in full and limited detent.

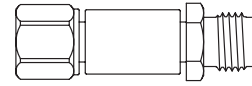

Model 8535

## 75 Ohm DC Blocks, In Series

8174	0.01-2	F-M/F	200	INNER
8175	0.01-2	F-M/F	200	OUTER
8176	0.01-2	F-M/F	200	INNER-OUTER
8184	0.1-4	N-M/F	200	INNER
8185	0.1-4	N-M/F	200	OUTER
8186	0.1-4	N-M/F	200	INNER/OUTER
8181	0.1-4	BNC-M/F	200	INNER
8182	0.1-4	BNC-M/F	200	OUTER
8183	0.1-4	BNC-M/F	200	INNER/OUTER

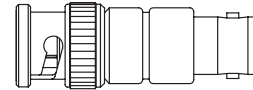

Model 8181

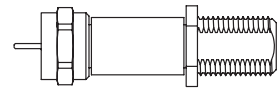

Model 8174

## DC Blocks, Between Series

8313	0.01-4	BNC-M/SMA-F	100	INNER
8301	0.01-18	N-M/SMA-M	200	INNER
8302	0.01-18	N-M/SMA-F	200	INNER
8303	0.01-18	N-F/SMA-M	200	INNER
8304	0.01-18	N-F/SMA-F	200	INNER
8306	0.01-40	2.4mm-M/2.9mm-F	200	INNER
8309	0.01-40	2.4mm-F/2.9mm-M	200	INNER
8180	0.01-40	2.4mm-F/2.9mm-F	200	INNER

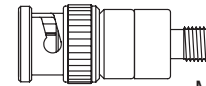

Model 8313

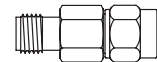

Model 8306

## DC Blocking Attenuators (Also see Attenuator Section, page 6)

8516S-XX	0.01-2	SMA (0-10,12,15,20 dB)	200	INNER
8516N-XX	0.01-2	N (0-10,12,15,20 dB)	200	INNER
8516-XX	0.01-2	TNC (0-10,12,15,20 dB)	200	INNER
8528A-XX	0.01-2	F 75Ω(0-10,12,15,20 dB)	200	INNER

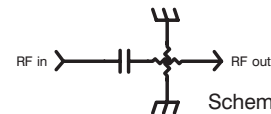

Schematic Diagram

## DC Blocking Terminations (Also see Termination Section, Page 10)

8530S	30 kHz-18	SMA	100	INNER
8530N	30 kHz-18	N	100	INNER
8530PF	30 kHz-23	SMP-F	100	INNER
8541-MPF	100 kHz-50	SMPM-M	10	INNER

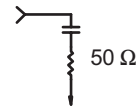

Schematic Diagram

## DC Blocking Connectors (Accepts \*0.009 and 0.012" Dia. Pins)

8537KF	20 kHz-45	2.9mm-F	25	INNER
8537KM	20 kHz-45	2.9mm-M	25	INNER
8537EF	20 kHz-45	2.4mm-F	25	INNER
8537EM	20 kHz-45	2.4mm-M	25	INNER
8537VF*	25 kHz-50	1.85mm-F	25	INNER
8537VM*	25 kHz-50	1.85mm-M	25	INNER

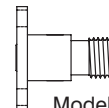

Model 8537KF

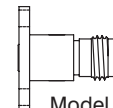

Model 8537EF

MODEL NO.      FREQ. (GHz)      CONNECTORS      CURRENT (Max.)      VOLTAGE (Max.)

### General Purpose and High Power Bias Tees

8800SMF1-02	.01-2.5	SMA-M/F	2.5A	100V
8800NMF1-02	.01-2.5	N-M/F	2.5A	100V
8800DMF1-02	.01-2.5	7/16-M/F	2.5A	100V
8800SMF1-04	.01-4	SMA-M/F	2.5A	100V
8800NMF1-04	.01-4	N-M/F	2.5A	100V
8800DMF1-04	.01-4	7/16 DIN-M/F	2.5A	100V
8800SMF1-06	.01-6	SMA-M/F	2.5A	100V
8800NMF1-06	.01-6	N-M/F	2.5A	100V
8800DMF1-06	.01-6	7/16-M/F	2.5A	100V
8800DMF1-07	.01-7.5	7/16-M/F	2.5A	100V
8800SMF1-09	.01-9	SMA-M/F	2.5A	100V
8800NMF1-09	.01-9	N-M/F	2.5A	100V
8800SMF1-12	.01-12.4	SMA-M/F	2.5A	100V
8800NMF1-12	.01-12.4	N-M/F	2.5A	100V
8820SMF1-02	.5-2.5	SMA-M/F	7.0A	100V
8820NMF1-02	.5-2.5	N-M/F	7.0A	100V
8820DMF1-02	.5-2.5	7/16 DIN-M/F	7.0A	100V
8821DMF1-02*	.5-2.5	7/16 DIN-M/F	7.0A	100V
8875NMF1-03	.01-3	N-M/F	2.5A	100V
8875FMF1-03	.01-3	F-M/F	2.5A	100V

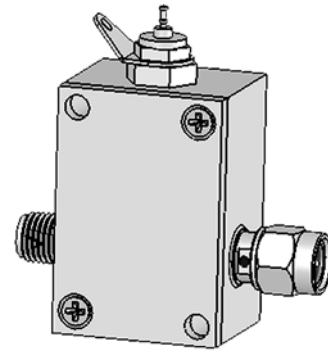

Model 8800SMF1

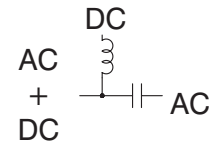

### Broadband Bias Tees

8810SMF2-12	50 kHz-12.4	SMA-M/F	750mA	25V
8810SMF2-18	50 kHz-18	SMA-M/F	750mA	25V
8810SMF2-26	50 kHz-26.5	SMA-M/F	750mA	25V
8810KMF2-26	50 kHz-26.5	2.9mm-M/F	750mA	25V
8810KMF2-40	50 kHz-40	2.9mm-M/F	150mA	25V
8810EMF2-50	50 kHz-50	2.4mm-M/F	150mA	25V
8812KMF2-26	12 kHz-26.5	2.9mm-M/F	150mA	16V
8812KMF2-40	12 kHz-40	2.9mm-M/F	150mA	16V

\*Environmentally Sealed

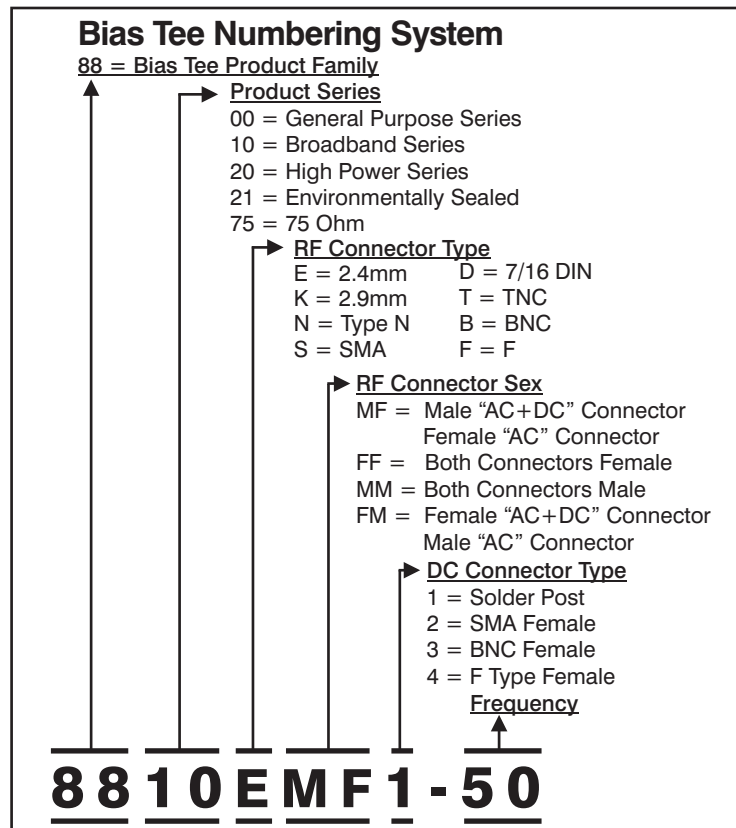

# Equalizer Overview



Gain equalizers are passive microwave components, which are designed to compensate for a variety of insertion loss slopes and irregularities to provide a flat output response. Inmet's adjustable designs are robust, easily tuned devices, that are stable under a variety of environmental conditions. Each equalizer model is custom made to meet our customer's unique loss slope and package requirements. Inmet has extensive design experience and staff dedicated to this product. Visit our web site at [www.aeroflex-inmet.com](http://www.aeroflex-inmet.com) and fill out the Equalizer Technical Questionnaire. We will supply you with a firm price and delivery quote and written technical proposal.

## Package Options

Coaxial, tubular, rectangular, drop-in and are available for your application.

## Loss Shapes – available in fixed or adjustable units

- Negative slope (Attenuation decreases as frequency increases)
- Positive slope (Attenuation increases as frequency increases)
- Parabolic slope (Used to compensate for gain of a TWT)
- Ripple slope (Used to remove ripple or IL spikes)

## Features

- 0.1 - 23 GHz
- Broadband or narrowband frequency performance
- Fine grain tuning capability
- Standard connectors: SMA, 2.9mm, N, TNC, SMP
- Meets MIL-Spec environmental requirements
- Custom designed
- Hybrids (Attenuators, DC Blocks, Isolators or Phase Shifters imbedded within the unit)

### Typical Equalizer Designs

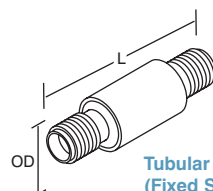
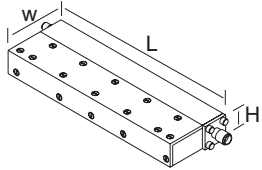

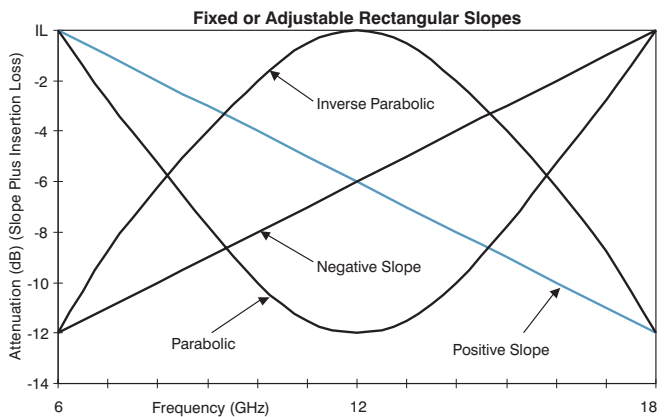
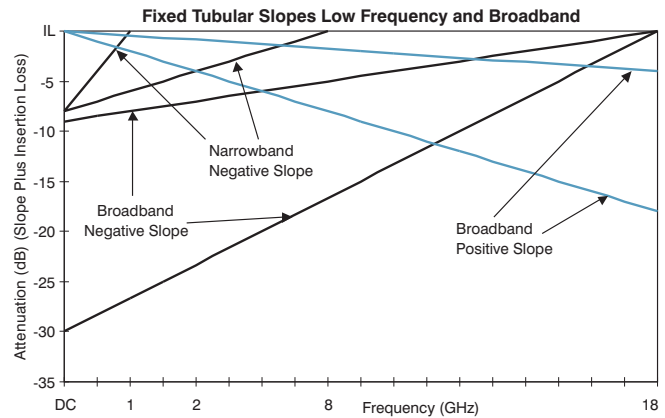

Frequency	Package Size	Slope	Insertion Loss	Linearity
<b>Tubular Style</b>				
0.05-0.65 GHz	L=3.18" OD=0.36"	6 dB	0.5 dB	±0.5 dB
0.5-2 GHz	L=2.28" OD=0.36"	5 dB	0.5 dB	±0.5 dB
0.5-2 GHz	L=2.28" OD=0.36"	15 dB	1.5 dB	±1 dB
2-8 GHz	L=1.69" OD=0.36"	5 dB	1.0 dB	±0.5 dB
2-8 GHz	L=1.69" OD=0.36"	15 dB	1.5 dB	±1 dB
0.1-18 GHz	L=1.21" OD=0.36"	3 dB	1.0 dB	±0.75 dB
0.1-18 GHz	L=1.21" OD=0.36"	10 dB	1.5 dB	±1 dB
0.1-18 GHz	L=1.21" OD=0.36"	30 dB	6.0 dB	±4 dB
0.5-18 GHz	L=1.21" OD=0.36"	5 dB	1.5 dB	±0.75 dB
0.5-18 GHz	L=1.21" OD=0.36"	10 dB	2.0 dB	±1 dB
0.5-18 GHz	L=1.21" OD=0.36"	30 dB	6.0 dB	±4 dB
2-18 GHz	L=1.21" OD=0.36"	4 dB	1.0 dB	±0.75 dB
2-18 GHz	L=1.21" OD=0.36"	10 dB	2.0 dB	±1 dB
2-18 GHz	L=1.21" OD=0.36"	30 dB	6.0 dB	±4 dB
8-18 GHz	L=1.21" OD=0.36"	3 dB	1.0 dB	±0.5 dB
8-18 GHz	L=1.21" OD=0.36"	9 dB	3.0 dB	±1.5 dB
0.3-26.5 GHz	L=1.21" OD=0.36"	10 dB	2.0 dB	±1 dB
0.3-26.5 GHz	L=1.21" OD=0.36"	20 dB	4.0 dB	±3 dB
<b>Rectangular Style</b>				
0.8-2 GHz	3" x 3" x 0.5"	8 dB*	1.5 dB	±1 dB
2-4 GHz	2" x 1.5" x 0.5"	3 dB	0.5 dB	±0.5 dB
2-4 GHz	4" x 1.5" x 0.5"	15 dB*	2.0 dB	±1.5 dB
2-8 GHz	4" x 1.5" x 0.5"	10 dB	1.0 dB	±0.5 dB
2-8 GHz	4" x 1.5" x 0.5"	20 dB*	2.0 dB	±1.5 dB
4-8 GHz	4" x 1.5" x 0.5"	8 dB	1.0 dB	±0.75 dB
4-8 GHz	4" x 1.5" x 0.5"	20 dB*	2.0 dB	±1.5 dB
6-18 GHz	4" x 1.5" x 0.5"	10 dB	1.0 dB	±0.75 dB
6-18 GHz	4" x 1.5" x 0.5"	10 dB*	1.0 dB	±1 dB
6-18 GHz	4" x 1.5" x 0.5"	25 dB*	2.5 dB	±2 dB
8-12 GHz	4" x 1.5" x 0.5"	5 dB	0.5 dB	±0.5 dB
8-18 GHz	4" x 1.5" x 0.5"	10 dB	1.0 dB	±0.75 dB
8-18 GHz	4" x 1.5" x 0.5"	10 dB*	1.5 dB	±1 dB
17-23 GHz	2" x 1.25" x 0.5"	5 dB	0.75 dB	±0.5 dB

\* Parabolic

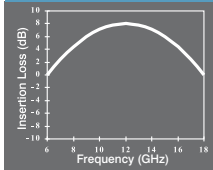

### Equalizer Math Made Simple



**PROBLEM:**  
Your Amplifier

+

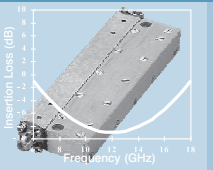

**SOLUTION:**  
Inmet's Equalizer

=

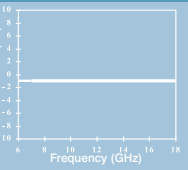

**RESULT:**  
Flat Response



MODEL NO.	FREQ. (GHz)	CONNECTOR	Minimum Gain
-----------	-------------	-----------	--------------

### Amplifiers

4205S	0.50-2	SMA	> 16 dB
4205N	0.50-2	N	> 16 dB
4205T	0.50-2	TNC	> 16 dB



### Open Circuits (also available with chain, add suffix "C")

7004	18	N-M
7005	18	N-F
7006	18	SMA-M
7007	18	SMA-F
7013	7.5	7/16 DIN-F
7014	7.5	7/16 DIN-M
7015	3	F-M
7016	3	F-F
7041	40	2.9mm-M
7042	40	2.9mm-F
7045	50	2.4mm-M
7046	50	2.4mm-F

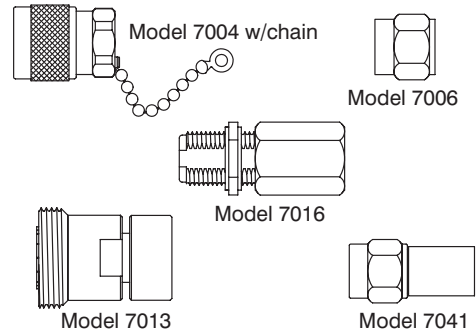

### Short Circuits (also available with chain, add suffix "C")

7001	18	N-M
7002	18	N-F
7008	18	SMA-M
7009	18	SMA-F
7011	7.5	7/16 DIN-F
7012	7.5	7/16 DIN-M
7017	3	F-M
7018	3	F-F
7039	40	2.9mm-M
7040	40	2.9mm-F
7043	50	2.4mm-M
7044	50	2.4mm-F

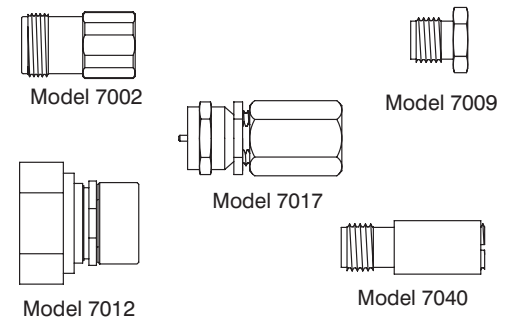

### Power Dividers

6007-02	12.4	N	
6007	18	N	
6011-02	12.4	N	
6011	18	N	
6014-01	12.4	SMA	Also available as 6014 F
6014-02	18	SMA	
6014-03	6	SMA	
6019-02	12.4	TNC	
6019	18	TNC	
6005-01	12.4	2.9mm	Also available as 6005 F
6005-02	18	2.9mm	
6005-03	26.5	2.9mm	

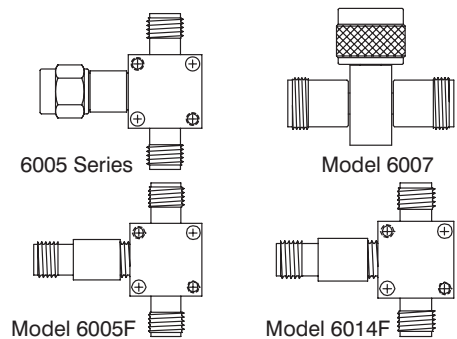

### Zero Bias Schottky Detectors

MODEL NO.	FREQ. (GHz)	CONNECTOR	Flatness
4802S	2	SMA-M/F	+/- 0.2 dB TYP.
4804S	4	SMA-M/F	+/- 0.2 dB TYP.
4808S	8	SMA-M/F	+/- 0.3 dB TYP.
4812S	12.4	SMA-M/F	+/- 0.3 dB TYP.

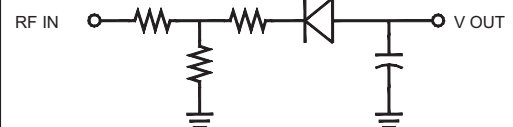

### Dust and Moisture Sealing Caps (also available with chain, add suffix "C")

MODEL NO.	CONNECTOR
7602	TNC-M
7603	SMA-M
7604, 7605	N-M, N-F
7606	2.4mm-M
7607	SMP-F

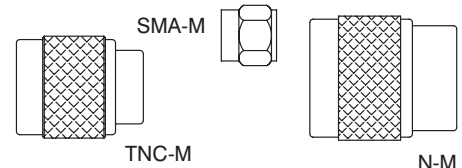

## How to Order

When ordering, state the model number, description of the component and the frequency range as given in the catalog.

You may place your order with the factory, Richardson Electronics, or the Aeroflex / Inmet Sales Representative in your area. Factory orders will be accepted by mail, telephone or other electronic communications pending confirmation on your standard purchase order form. Minimum factory order is \$250.00 and subject to change. Quantity minimums may apply for non-standard or special order products.

Address all orders and communications to:

AEROFLEX / INMET INC.  
300 Dino Drive  
Ann Arbor, MI 48103 USA

Tel.: 888-244-6638 or 734-426-5553

Fax: 734-426-5557

E-mail: [sales@aeroflex-inmet.com](mailto:sales@aeroflex-inmet.com)

Web: [www.aeroflex-inmet.com](http://www.aeroflex-inmet.com)

CAGE Code: 64671

## Payment Terms

Terms are net 30 days for customers with established credit. All other orders must be prepaid, paid by credit card (VISA and MasterCard accepted) or C.O.D.

## Shipping

All sales are F.O.B. Ann Arbor, Michigan. Unless specified in your order, orders will be shipped "best way" at the company's discretion. Aeroflex / Inmet can only guarantee shipping date. Factory does not assume responsibility for carrier delays and cannot be held responsible for late, lost or damaged shipments. All claims must be filed with the carrier.

## Certificate of Compliance

A Certificate of Compliance is shipped with every order. It is located on the reverse side of the packing slip.

## Warranty

Aeroflex / Inmet Corporation warrants each product it manufactures to be free from defects in material and workmanship under normal use and service. Aeroflex / Inmet's only obligation under this warranty is to repair or replace, at its factory, any product or part thereof that is returned, with transportation charges prepaid, by the original purchaser within ONE YEAR from the date of shipment.

The foregoing warranty does not apply to, and in Aeroflex / Inmet's sole opinion, products that have been subject to improper or inadequate maintenance, unauthorized modifications, misuse, or operation outside the published specifications for the product.

The warranty stated above is the sole and exclusive warranty and is in lieu of all other warranties, expressed or implied, including, but not limited to, any implied warranty or fitness for any particular purpose. Aeroflex / Inmet shall not be liable for any direct or consequential injury, loss or damage incurred through the use, or inability to use any Aeroflex / Inmet product.

## Returns

When returning a component to our factory, a Return Material Authorization (RMA) number must be obtained from Aeroflex / Inmet. When contacting us for an RMA number, please indicate the model number, date of the original purchase, the product lot number and the original invoice number for the purchase. Please also include as much information as possible, including test data, pertaining to the nature of the malfunction or reason for the return and point of contact information for your company.

## Cancellations

Orders placed with Inmet may be cancelled only after authorization from Aeroflex / Inmet. Any authorized cancellation is subject to cancellation charges as determined by Aeroflex / Inmet. A component returned for credit will be subject to a restocking charge. If more than 6 months has elapsed since original purchase, the item may not be accepted for credit. Nonstandard components as determined by Aeroflex / Inmet, cannot be returned for credit.

## Product Changes

Although all information in this catalog is current at the time of release, Aeroflex / Inmet continuing Product Improvement Program makes it necessary for Aeroflex / Inmet to reserve the right to change specifications without notice.

## Quality Assurance

Aeroflex / Inmet's goal is to achieve complete customer satisfaction in the design, quality, delivery, pricing and support of our products. We continue to develop and improve our management systems and manufacturing processes in order to meet this goal.

Aeroflex / Inmet's Quality Assurance system is registered to ISO-9001. Our calibration program for inspection and test equipment complies with the requirements of MIL-STD 45662 and ANSI/NCSS Z540-1.



Certificate No. US-1943

Visit our website: [www.aeroflex-inmet.com](http://www.aeroflex-inmet.com)

Inmet's website can keep you up-to-date about Aeroflex-Inmet and it's products. Here's a mini-tour of the site:

**Corporate Information** includes links to our Company Profile, current Corporate News, information on Quality Assurance, names and e-mail addresses of key Corporate Contacts, Directions for the Facility, and Corporate Links to other Aeroflex Companies.

**Product Information** features Aeroflex / Inmet's complete product line. The data sheets for the products listed in this short form catalog are available in PDF format on the website. Revisions and updates to existing data sheets are posted on the site as they become available. And, should you need additional copies of any particular data sheet, go to the website, point, click and print.

**New Products** and information about them, are found here. You will also find data sheets in PDF format on all the new products which are easy to print or download.

**Reps & Distributors** enables you to locate the sales representative serving your area as well as information about Richardson Electronics, our exclusive global Distributor.

**Career Opportunities** lists current positions available, the qualifications for each, and information on how to apply.

**Favorite Sites** provides links to other internet websites that you may find helpful. Included are links to industry magazines, industry trade shows, university relationships, etc.

## Exclusive Global Distributor

*rfwireless.rell.com*  
or call 800-737-6937 (U. S. & Canada)

**Corporate Headquarters**

Richardson Electronics  
40W267 Keslinger Road  
P.O. Box 393  
LaFox, IL 60147-0393  
Telephone: (800) 737-6937  
(630) 208-3637  
Fax: (630) 208-2550  
Internet: [rfwireless.rell.com](http://rfwireless.rell.com)  
E-Mail: [rw@rell.com](mailto:rw@rell.com)

**North America**

Eastern Sales Region Hdqtrs.  
Ronkonkoma, NY  
Telephone: (800) 737-6937  
(631) 468-3900  
Fax: (631) 468-3950

Central Sales Region Hdqtrs.

LaFox, IL  
Telephone: (800) 737-6937  
(630) 208-3637  
Fax: (630) 208-2662

Western Sales Region Hdqtrs.

Woodland Hills, CA  
Telephone: (800) 737-6937  
(818) 594-5600  
Fax: (818) 594-5650

Northwest Sales Region Hdqtrs.

San Jose, CA  
Telephone: (800) 737-6937  
(408) 428-3400  
Fax: (408) 428-3450

Southeast Sales Region Hdqtrs.

Altamonte Springs, FL  
Telephone: (800) 737-6937  
(407) 339-6060  
Fax: (407) 339-6650

U.S. Exporters

Brooklyn, NY  
Telephone: (800) 882-3397  
(718) 265-8200  
Fax: (718) 265-8250

**Canada**

Brampton, Ontario  
Telephone: (800) 737-6937  
(905) 789-3000  
Fax: (905) 789-3050

**Latin America**

Brazil  
São Paulo  
Telephone: + (55) 11 5186 9655  
Fax: + (55) 11 5186 9678

Colombia

Sante Fe de Bogota, DC  
Telephone: (57-1) 636-1028  
Fax: (57-1) 636-1005

**Mexico**

Mexico City  
Telephone: +52 (5) 55 532-2522  
Fax: +52 (5) 55 609-0006

Guadalajara

Telephone: +52 (3) 331230041  
Fax: +52 (3) 331220565

**Europe**

Denmark  
Hedenhusene  
Telephone: (+45) 4655-5630  
Fax: (+45) 4655-5631

Estonia

Telephone 603-5511-5421  
Fax: 603-5511-5423

Finland

Oulunsalo  
Telephone: +358-8-825-1100  
Fax: +358-8-825-1110

France

Colombes Cedex  
Telephone: +33 (1) 55.66.00.30  
Fax: +33 (1) 55.66.00.31

Germany  
Puchheim

Telephone: +49 (89) 890 214-0  
Fax: +49 (89) 890 214-90

**Italy**

Sesto Fiorentino (FI)  
Telephone: +39 (055) 420831  
Fax: +39 (055) 4210726

Agrate Brianza (MI)

Telephone: +39 (039) 653145  
Fax: +39 (039) 653835

Roma

Telephone: +39 (06) 41.73.37.51  
Fax: +39 (06) 41.73.37.49

Norway

Torod  
Telephone: +47 333-86271  
Fax: +47 333-83106

Sweden

Stockholm  
Telephone: +46 8 564 705 90  
Fax: +46 8 760 4663

Spain

Madrid  
Telephone: +34 (91) 528 3700  
Fax: +34 (91) 467 5468

Barcelona

Telephone: +34 (93) 415 8303  
Fax: +34 (93) 415 5379

**United Kingdom**

Lincoln  
Telephone: +44 (1522) 542631  
Fax: +44 (1522) 545453

Slough

Telephone: +44 (1753) 733010  
Fax: +44 (1753) 733012

**Middle East**

Israel  
Ra'Anana  
Telephone: 972-9-7483232  
Fax: 972-9-7416510

**Asia/Pacific Rim/Australia**

Australia  
Castle Hill  
ABN 19 069 808 108  
Telephone: +61 (2) 9894-7288  
Fax: +61 (2) 9894-7481

Bayswater

ABN 19 069 808 108  
Telephone: +61 (3) 9738-0733  
Fax: +61 (3) 9738-1807

China

Beijing  
Telephone: +86-10-65885547  
+86-10-65885548  
Fax: +86-10-65885541

Chengdu

Telephone: +86-28-8620-3488  
Fax: +86-28-8620-3499

Shanghai

Telephone: +86 (21) 62351788  
Fax: +86 (21) 6440-1293

Shenzhen

Telephone: +86-755-82943736  
Fax: +86-755-82940656

Japan

Tokyo  
Telephone: +81 (3) 5844-0521  
Fax: +81 (3) 5844-0527

Korea

Seoul  
Telephone: +82 (2) 539-4731  
Fax: +82 (2) 539-4730

Malaysia

Selangor  
Telephone: +60 (3) 5511-5421  
Fax: +60 (3) 5511-5423

Philippines

Pasig City  
Telephone: +63 (2) 636-8891  
Fax: +63 (2) 635-5721

Singapore

Telephone: +65 6487-5995  
Fax: +65 6487-5665

Taiwan

Taipei  
Telephone: +886 (2) 26983288  
+886 (2) 86915238  
Fax: +886 (2) 26983285

Thailand

Bangkok  
Telephone: +66 (2) 749-4402  
Fax: +66 (2) 749-4403

Vietnam

Ho Chi Minh City  
Telephone: +84 89974245  
+84 89974246  
Fax: +84 89974071



**AEROFLEX**  
A passion for performance.

300 Dino Drive  
Ann Arbor, MI 48103-9457  
[www.aeroflex-inmet.com](http://www.aeroflex-inmet.com)  
1-888-244-6638 or 734-426-5553



Our passion for performance is defined by three attributes represented by the icons pictured above: solution-minded, performance-driven and customer-focused.