

Electrical Specifications

Frequency Range, GHz	2 ~ 26.5
Impedance, Ohms	50
Insertion Loss Max.[dB]	1.2
Amp.Bal. Max.[dB]	±0.3
Input VSWR Max.	1.5
Output VSWR Max.	1.5
Isolation Min.[dB]	18
Phase Bal. Max.[Deg.]	±3
CW Power Max.[W]	20
Peak Power Max.[kW]	3

Mechanical Specifications

Conn.Type	SMA(F)
Weight Max[g]	60
Operating Range deg.[C]	-35 ~ 105
Color	Black

Outline Drawing

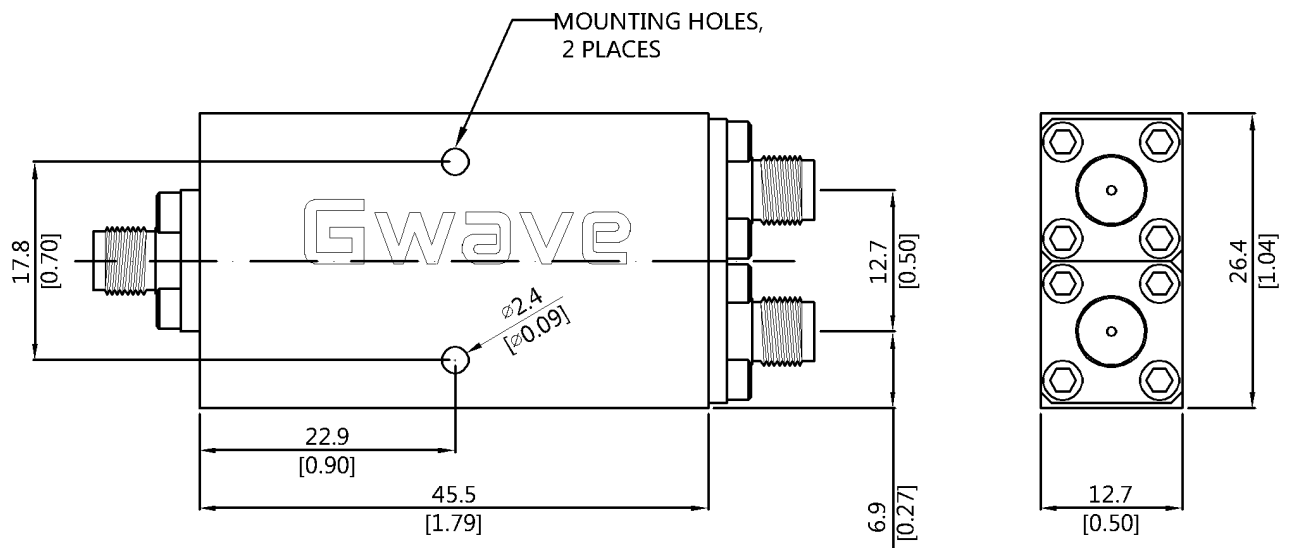

Notes

- Insert loss does not include theoretical power distribution insert loss[3dB].
- Compliant MIL-STD-810G environment test standard.